

The Agreement between Clar Structures and Nucleus-Independent Chemical Shift Values in Pericondensed Benzenoid Polycyclic Aromatic Hydrocarbons: An Application of the Y-Rule

Yosadara Ruiz-Morales*

Programa de Ingeniería Molecular, Instituto Mexicano del Petróleo, Eje Lázaro Cárdenas 152, Mexico City 07730, Mexico

Received: February 27, 2004; In Final Form: August 27, 2004

In the present study, we verify theoretically the performance of a previously introduced qualitative simple rule for aromaticity, the *Y-rule*, which determines the relative aromaticity of each hexagonal ring in pericondensed benzenoid polycyclic aromatic hydrocarbons (peri-PAHs). The *Y-rule* extends the sextet–double bond description of Clar’s model for peri-PAHs by predicting, in an easy way, the most likely location and total number of aromatic sextets in the structure. The final π -electronic distribution thus obtained corresponds to the superposition of the most important Clar structures. The problem of the number and location of aromatic sextets in peri-PAHs involves the very concept of aromaticity. The π -electronic distribution obtained by the Clar sextet principle (or model) as determined by the *Y-rule* is compared with the π -electronic distribution obtained from nucleus-independent chemical shift (NICS) calculations for various series of benzenoid peri-PAHs. The NICS values were used to assess the relative aromaticities of the individual rings in the peri-PAH compounds. We found that the simple heuristic *Y-rule* predicts for all the calculated systems the same relative aromaticities given by the NICS calculations, and for the case of peri-systems with very high symmetry (like the compact peri-PAHs) it reinforces the picture derived from the NICS calculations. In these cases, the NICS results can be complex due to symmetry. The advantages of the qualitative *Y-rule* are that it is of particular importance for the case of large peri-PAHs, it takes only a few minutes to be applied following a very easy methodology, and it provides a quick answer about the aromaticity and location of the resonant sextets in peri-PAH compounds without having to carry out theoretical quantum chemistry calculations that take time and that can be costly depending on the size of the system.

1. Introduction

One of our major interests is the understanding of the structure of petroleum asphaltene and their aggregation process.^{1–6} Asphaltene are thought to be polycyclic aromatic compounds (PACs) similar to pericondensed polycyclic aromatic hydrocarbons (peri-PAHs) but containing heteroatoms (N, O, S) and alkyl side chains in their structure; see Figure 1.

We showed in a previous study⁷ that the stability and reactivity of the asphaltene molecules are closely associated to the stability and reactivity of their polycyclic aromatic hydrocarbon (PAH) core. The highest occupied molecular orbital–lowest unoccupied molecular orbital (HOMO–LUMO) gap magnitude of benzenoid PAHs is related to their aromaticity (i.e., to the number of aromatic resonant sextets (Clar’s sextets) present in the structure) which in turn is related to the spatial distribution of the hexagonal fused rings.^{7–9} Thus, to understand the aromaticity and reactivity of asphaltene, it is necessary to understand the aromaticity of peri-PAHs.

The concept of aromaticity has been under discussion for more than 135 years since its introduction mainly because neither the aromaticity nor the ring currents (delocalization of π -electrons) are physical observables. Clar^{8,9} was the closest in recognizing the aromaticity of benzenoid PAHs. He proposed the Clar structures of the PAH compounds presented in his book *The Aromatic Sextet* by studying their reactivities, NMR properties, and UV spectra and combining the experimental facts with his intuition.⁹ Clar’s work shows that the placement of

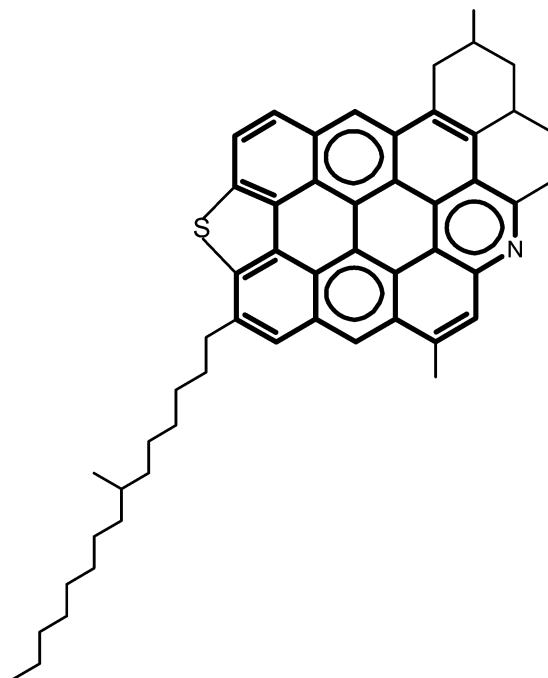

Figure 1. A proposed structure of a petroleum asphaltene.^{1a} The fused aromatic ring (FAR) region, composed by a pericondensed polycyclic aromatic hydrocarbon (peri-PAH) core with heteroatoms, is highlighted in bold.

resonant sextets in PAHs is not completely arbitrary. His work can be summarized through Clar’s rules. The aromatic sextets

* Corresponding author e-mail: yruiz@imp.mx

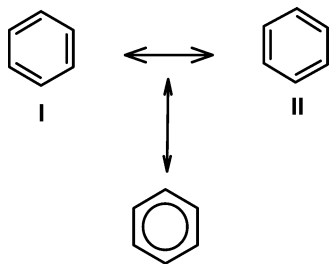

Figure 2. Resonant sextet. The resonant sextet confers a stability of 36 kcal/mol to benzene, and it involves 6 π electrons.

are localized to a single benzene ring separated from adjacent benzene rings by formal C–C single bonds (i.e., sextet rings and formal double bonds must be separated by one formal single bond from each other). Sextet rings are considered to be main aromatic centers. Formal double bonds indicate that these C–C bonds have polyene-like character, and the best Clar structure is the closed-shell one with a maximum number of sextet rings. Another way to put the Clar rules, to generate Clar structures, which contain Clar aromatic sextets, is the one given by Dr. Randic in ref 10: “Inscribe in non-adjacent benzene rings of a polycyclic benzenoid hydrocarbon the maximal number of circles (π -sextets) so that for bonds not involved in π -sextets one can complete the Kekulé valence structure.”

The individual benzene rings are the main contributors to the aromaticity of benzenoid polycyclics. A Clar structure^{8,9} for a PAH molecule is depicted as a combination of the maximum number of isolated and *localized* aromatic sextets, for that molecule, with a minimum number of localized double bonds.⁹ In general, a PAH molecule with a given number of aromatic sextets is kinetically more stable than its isomers with less aromatic sextets.^{7,8}

Clar’s resonant sextet or aromatic resonant sextet implicates three double bonds that in total involve six π electrons that are permutable within the same hexagonal ring. In Figure 2, the resonant sextet of benzene is shown. The circle notation represents the resonance of states I and II; see Figure 2. The term “aromatic stabilization”^{11–17} is still well accepted and is estimated to be 36 kcal/mol for benzene (i.e., for each resonant sextet present in the PAH structure).

There are PAH compounds that have only a single Clar structure; in this group the full resonant structures or “fully benzenoid” are included. There are benzenoid PAH compounds for which one cannot draw a unique Clar structure. For these cases, one has to draw two or more Clar structures due to the occurrence of π -sextet migration.^{8–10,18} Here is where we get in trouble.

Just as is the case with the Kekulé valence structures, there are many benzenoid hydrocarbons that have more than one Clar structure (with the highest number of resonant sextets).¹⁰ Which one should one draw? Which one or ones are the responsible for the aromaticity? The pioneering work of Clar on the clarification of the aromaticity makes skillful use of the placement of the sextets through Clar’s rules. However, the Clar rules, as they are, only help us to construct Clar structures but do not help us to solve these questions. Clar’s rules do not tell us, in an easy way, which is the most important Clar structure(s) to represent any peri-PAH’s aromaticity. Mainly due to this situation there is an unfortunate and misleading misuse of the circle notation to represent aromatic sextets in PAHs. The misuse of the circle notation, in all of the hexagons, in PAH structures to represent the π -electronic distribution and aromaticity must stop.

Fries¹⁹ suggested that a single Kekulé valence structure having the maximal number of Kekulé benzene rings is dominant. The valence bond calculations assume that all Kekulé valence structures, some in greater extent than others, contribute toward the description of conjugated PAHs, and according to Clar some Kekulé valence structures apparently are more important for characterization of properties of benzene hydrocarbons than others. About this situation Randic mentions in the prologue of ref 10:¹⁰

When more than one Clar structure is possible, we select the most important Clar structure, which *has yet to be recognized* ... Molecules with symmetry may have more than one such ‘most important’ Clar structure that will be symmetry-related. It is an open problem to establish whether there are two or more symmetry-unrelated Clar structures having the same number of quinoidal rings, in which case additional criteria may have to be considered to establish the most important Clar structure.

Other limitations of Clar’s model is that some large poly-benzenoid systems have but few Clar structures, which can proliferate with increases in size of the system. This is the case of the second higher member of the “cove” homologous series starting with hexabenzocoronene where there is a drastic proliferation, possibly an exponential growth, of Clar structures.¹⁰

On the other hand, there are exceptions to Clar’s rules such as the cases of benzocoronene and tetrabenzoperylene for which Clar proposed “lesser” Clar structures in order to account for some observed chemical behavior.¹⁰ These “anomalies” led to the notion of the “generalized Clar structures” of Hosoya and Yamaguchi,²¹ which are obtained from a Clar structure by erasing one or more aromatic sextets. This in turn led to the “canonical Clar structures” defined by Herndon and Hosoya,²² which are a particular subset of the generalized Clar structures, and to the “resonant Clar structures” of Randic,^{10,23} which are constructed by the superposition of only Kekulé structures with the same degree of freedom.

The understanding of the aromaticity in peri-PAHs will provide the most important Clar structure that might be unique for some PAHs or the resultant of the superposition of two or more “most important Clar structures”. In this direction, several efforts have been done to calculate the aromaticity in PAHs.

Hosoya²⁴ et al. and Aihara²⁵ proposed an extension of the Hückel rule which can reasonably be applied to the polycyclic aromatic hydrocarbons systems to determine their aromaticity. The Hückel rule strictly applies to monocyclic polyenes. Hosoya et al.²⁴ introduced a modified semianalytical topological index as stability criterion of PAHs. The modified topological index is proposed for estimating the total π -electron energy. Other approaches in the literature to aromaticity criteria are the Herndon–Randic theory of conjugated circuits,^{26–31} Aihara’s graph theory,²⁴ and Schleyer’s nuclear independent chemical shift (NICS).³² All of these theories are consistent with the Clar concept of aromatic sextets.^{8,9}

Several aromaticity indices are defined in the literature based on different criteria.^{12,24–32} There are energy-, geometry-, and magnetic-based aromaticity indices. The magnetic-based aromaticity indices such as the nucleus independent chemical shift (NICS)³² are related to the magnetic properties of molecules. Molecules with cyclic conjugated π -electron systems, like benzene and PAHs, present a stronger diamagnetic susceptibility as compared to noncyclic conjugated π -systems. The “magnetic anomaly” is due to the ring currents in the π -electron system.³³

The nucleus-independent chemical shift (NICS) was introduced by Schleyer et al.³² in 1996 as a new aromatic index which is defined as the negative value of the absolute isotropic magnetic shielding at some selected point in space (e.g., at the center of a ring that is being probed, NICS(0), or 1 Å above the geometrical center of the ring that is being probed, NICS(1)). The NICS data are reported with the reverse signs in order to conform to the NMR chemical shift conventions (negative upfield and positive downfield). Significant negative (i.e., magnetically shielded) NICS values in interior positions of rings or cages indicated the presence of induced diatropic ring currents or “aromaticity” whereas positive values (i.e., deshielded) at each position denote paratropic ring currents and “antiaromaticity”.³² The NICS criterion is now widely applied³⁴ in many *ab initio* and density functional studies which have demonstrated that NICS is a useful indicator of aromaticity and generally correlates well with the energetic, geometric, and magnetic criteria for aromaticity.³⁵

However, none of the aromaticity theories provides, in an easy and direct way, information about the maximum number of resonant sextets present in PAH structural isomers and their topological localization in the structure (i.e., none of them establishes in an easy way the most important Clar structure(s)). Which Clar structure or structures of any peri-PAH are most responsible of its aromaticity? To answer this question is even more complicated for the case of large peri-PAHs. Schleyer, who is the world’s leading proponent of the magnetic criterion for aromaticity, has mentioned³⁴ that large polycyclic aromatic hydrocarbons, referring in particular to those synthesized in Mainz and described by Watson et al.,³⁶ indeed, “... are beautiful and these extended π systems create challenging problems for any discussions into π -structure ...”

Watson et al.³⁶ have shown that macromolecular and supramolecular structures can be obtained upon use of benzene as a regular building block and they have focused on the occurrence of π conjugation, or lack thereof, originating from the repetition of the aromatic benzene units in various motifs for the construction of new materials. The size, the topology of the ring fusion, and the periphery of PAHs as molecular graphite subunits are crucial not only for the electronic discussion at the molecular level but also for the packing of PAHs in both two and three dimensions. Particularly mixed ordered layers of electron-rich and electron-poor conjugated molecules open new applications for molecular electronics.^{36–38} Recently Samori et al.³⁸ have reported the self-assembly of very large unsubstituted PAHs from solutions into epitaxial composites for the fabrication of high-performance electronic devices. The donating or accepting properties of these nanographenes are controlled by their size and shape as well as functionalities in their periphery.³⁸ The understanding of the π -density distribution in these systems, by finding the most important Clar structures out of all the possibilities, is a challenge that has to be overcome in an easy practical way. For this purpose, we propose the use of the Y-rule.

In a previous paper,⁷ we presented a new qualitative rule, the *Y-rule*, which determines the number of resonant sextets and their most likely localization in benzenoid peri-PAHs, or in the periphery in PAHs, without having to calculate the electronic structure of the system or to calculate the aromaticity with a theoretical expensive method.

The validity of the Y-rule has already been proven experimentally. It has been used to explain the observed 0–0 fluorescence emission band of peri-PAHs,⁷ and very recently Bergmann et al.³⁹ have found a correlation of the $1s-\pi^*$ line width, obtained from carbon K edge X-ray Raman spectroscopy,

with the carbon atom ratio in peri-PAHs (double bond/aromatics) obtained with it.

In the present paper, we compare the π -electronic distribution obtained from the Clar sextet principle, as determined by the Y-rule, with the π -electronic distribution obtained from the NICSs to verify theoretically the performance of the Y-rule, which helps to establish the most important Clar structures (MICSs) in peri-PAHs, of any size, and the superposition of the MICS gives as a result the π -electronic distribution responsible of the aromaticity. The NICS values are used to assess the relative aromaticities of the individual rings in small and large peri-PAH compounds. It has already been demonstrated in the literature^{10,18,32,34,35,40,41} that the NICS values represent strong theoretical support for Clar’s picture of aromatic π sextets. The advantages of the qualitative Y-rule are that it is of particular importance for the case of large peri-PAHs, it takes only a few minutes to be applied following a very easy methodology, and it provides a quick answer about the aromaticity and location of the resonant sextets without having to carry out theoretical quantum chemistry calculations that take time and that can be costly depending on the size of the system.

2. Computational Details

The structural optimization of the PAH systems was done by performing force-field-based minimization using the energy minimization panel in Cerius2 version 4 and the COMPASS consistent force field as it is provided in the Cerius2 package.⁴²

COMPASS (condensed-phase optimized molecular potentials for atomistic simulation studies) force field was used in all the optimizations because it has been tested and validated extensively against experiment for many organic molecules.

The NICS calculations were carried out using the GIAO-DFT⁴³ method as implemented in the Gaussian 98⁴⁴ package using the force field optimized structures.

A dummy atom was located on the molecular plane at the geometrical center of each hexagon in the PAH structures to calculate the NICS(0), and at 1 Å above the molecular plane to calculate the NICS(1). Becke’s 1988 functional, which includes the Slater exchange along with corrections involving the gradient of the density,⁴⁵ was used together with the correlation functional of Lee, Yang, and Parr,⁴⁶ which includes both local and nonlocal terms (i.e., B3LYP functional).

It is well-known that the shielding tensor and NICS are very sensitive to the quality and size of the basis set used.^{47,48} Schleyer et al.^{18,32,40,41} recommend the use of the 6-31G(d) basis. However, a sufficiently large basis is needed for an accurate description of the chemical shift. Thus, we used a basis set that is augmented with two sets of polarization functions (i.e., the 6-31G(d, p) basis set).⁴⁴

All of the compounds are numbered according to the figure where they appear. We use a combination of an Arabic number and a letter. In general, the Arabic number corresponds to the figure number and the letter to the different compounds considered in that figure.

3. Results and Discussion

3.1. The Y-Rule in Identifying Clar Structures. In a previous study,⁷ we found that the magnitude of the HOMO–LUMO gap in benzenoid PAHs is closely related to the number of fused aromatic rings (n FARs), to the spatial arrangement of the fused rings, to the percentage of compactness or degree of condensation (P_C) of the structure, and to the number and location of resonant sextets (N_R) in the structure.⁷

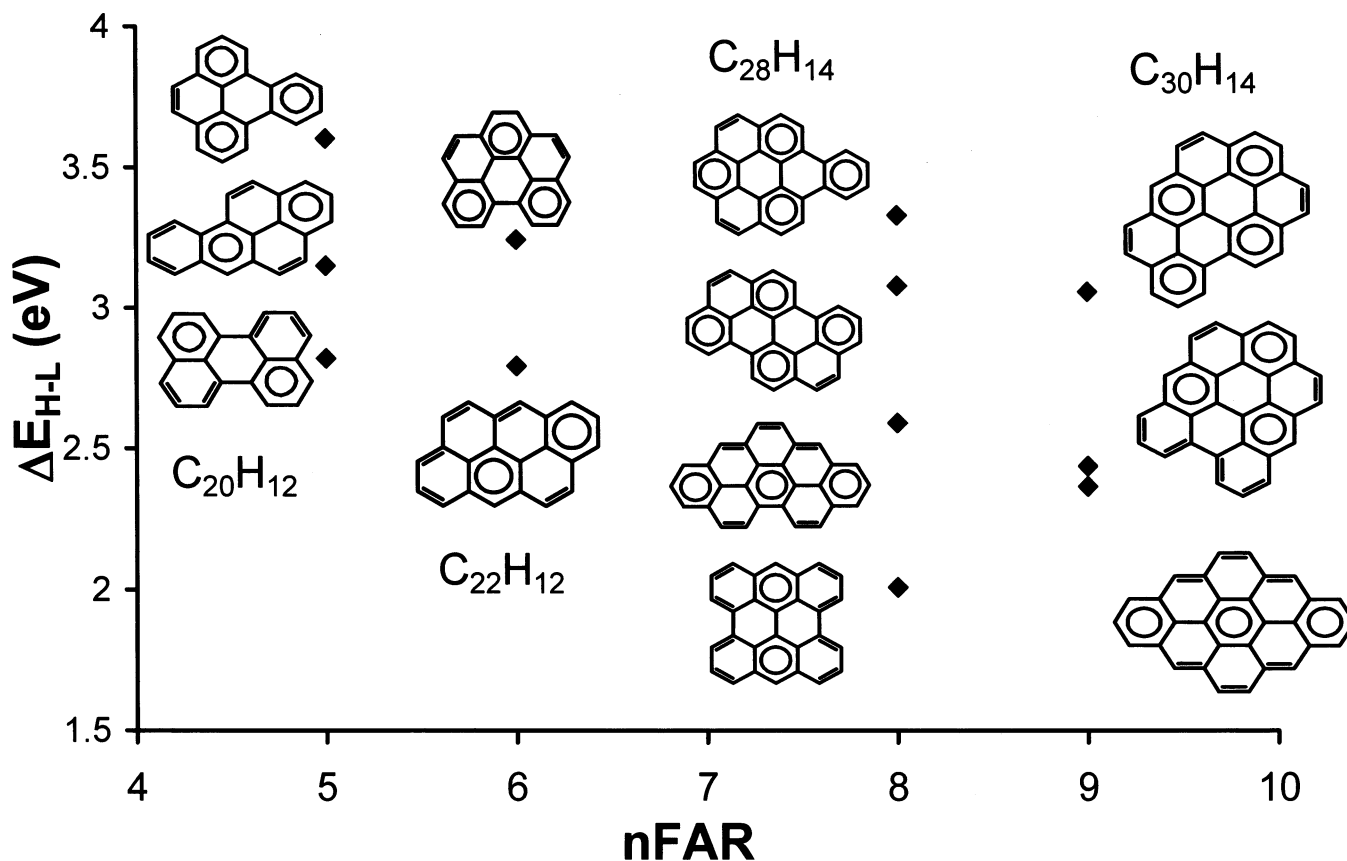

Figure 3. Calculated HOMO–LUMO gap for some benzenoid polyaromatic hydrocarbon compounds with five, six, eight, and nine fused aromatic rings (5FAR, 6FAR, 8FAR, and 9FAR). The compounds of each FAR family are isomers with the same stoichiometry and same structural parameters.

TABLE 1: Number of Nonradical Isomers Associated to Each Stoichiometry of FAR Systems and Structural Parameters

system	stoichiometry ^f	$P_C^{h,d}$	number of isomers ^a	N_R^b	N_{DB}^b	d_s^b	C_Y^b	C_{PA3}^b	C_{Int}^b
4FAR	C ₁₆ H ₁₀	100%	1 ⁱ	2	2	0	2	4	6
5FAR	C ₂₀ H ₁₂	50%	3	3, 2	1, 4	1	2	6	8
6FAR	C ₂₂ H ₁₂	82%	2	3, 2	2, 5	0	4	6	10
7FAR	C ₂₄ H ₁₄	33%	13 (1) ^e	4 (full), ^g 3, 2	0, 3, 6	2	2	8	10
	C ₂₄ H ₁₂	100%	1 ⁱ	3 ^h	3	-1	6	6	12
	C ₂₆ H ₁₄	65%	9	4, 3, 2	2, 4, 7	1	4	8	12
8FAR	C ₂₈ H ₁₆	25%	62	4, 3, 2	2, 5, 8	3	2	10	12
	C ₂₈ H ₁₄	75%	8	4, 3, 2	2, 5, 8	0	6	8	14
	C ₃₀ H ₁₆	45%	58 (1) ^e	6 (full), ^g 5, 4, 3, 2	0, 3, 6, 9, 12	2	4	10	14
9FAR	C ₃₂ H ₁₈	20%	295 ^c	5, 4, 3, 2	1, 4, 7, 10	4	2	12	14
	C ₃₀ H ₁₄	89%	3	4, ^h 3, 2	3, 6, 9	-1	8	8	16
	C ₃₂ H ₁₆	60%	46	5, 4, 3, 2	1, 4, 7, 10	1	6	10	16
	C ₃₄ H ₁₈	33%	335 ^c	5, 4, 3, 2	2, 5, 8, 11	3	4	12	16
	C ₃₆ H ₂₀	16%	1440 (1) ^e	6 (full), ^g 5, 4, 3, 2	0, 3, 6, 9, 12	5	2	14	16
10FAR	C ₃₂ H ₁₄	100%	1 ⁱ	4	4	-2	10	8	18
	C ₃₄ H ₁₆	66%	34	5, 4, 3, 2	2, 5, 8, 11	0	8	10	18
	C ₃₆ H ₁₈	49%	337 (3) ^e	6 (full), ^g 5, 4, 3, 2	0, 3, 6, 9, 11	2	6	12	18
	C ₃₈ H ₂₀	28%	1987 ^c	6, 5, 4, 3, 2	1, 4, 7, 10, 13	4	4	14	18
	C ₄₀ H ₂₂	14%	6973 ^c	6, 5, 4, 3, 2	2, 5, 8, 11, 14	6	2	16	18

^a Reference 49. ^b See text and ref 7 for more detailed information about the topological elements. ^c Does not include stereoisomers. ^d Percentage of compactness. ^e Number of isomers with full resonant sextet structures and no localized double bonds. ^f The number of π electrons is equal to the total number of carbon atoms. ^g Total number of resonant sextets in the full resonant sextet structure. ^h Although the total number of π electrons in each of these stoichiometries is divisible by six, they cannot be full resonant structures or to reach the highest N_R because their P_C is higher than 79% from 7FAR on. ⁱ The systems with 100% of compactness have only one isomer.

In Figure 3, the calculated HOMO–LUMO gap of some peribenzenoid polyaromatic hydrocarbon compounds with five, six, eight, and nine fused aromatic rings (5FAR, 6FAR, 8FAR, and 9FAR) are presented.⁷ The compounds of each FAR family are isomers with the same stoichiometry, same number of π electrons, and same structural parameters; however the PAHs isomers, in a PAH family, with the highest number of resonant sextets present the largest HOMO–LUMO gap.

In Table 1, all of the stoichiometries for benzenoid peri-PAHs with 4 fused aromatic rings (4FAR) to 10 fused aromatic rings (10FAR) are given together with the percentage of compactness (P_C). The percentage of compactness is a measure of the degree of condensation of the PAH structure. The PAHs with 100% compactness have a structure that is the most compact; this is the case for the pure peri-condensed (circular) systems.

In Table 1 also, the topological elements for various peri-PAHs systems are provided. The topological elements that are

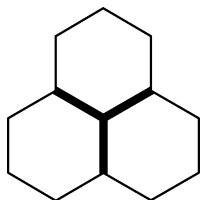

Figure 4. Schematic representation of an internal Y-carbon (C_Y). The internal carbons in the peri-PAH structures with a connectivity of three are called Y-carbons because they are in the vertex of what looks like a Y letter, which is highlighted in bold in the figure.

common to all PAH isomers having a given benzenoid molecular formula include^{7,49} (a) the number of σ bonds and π electrons, (b) the carbon and hydrogen content (C_A and H_A , respectively), (c) the total internal bridging carbons, C_{Int} , $C_{Int} = C_A - H_A$, (d) the number of fused aromatic rings ($nFAR$), $nFAR = (C_{Int} + 2)/2$, (e) the number of internal aromatic carbons with a connectivity of three (C_Y), $C_Y = -2 + nFAR - d_s$, (f) the number of peripheral aromatic carbons having a connectivity of three (C_{PA3}), $C_{PA3} = C_{Int} - C_Y = nFAR + d_s$, and (g) the net number of disconnections among the internal edges, d_s , $d_s = C_{PA3} - nFAR$. As can be seen, many of the terms mentioned are related by mathematical expressions.

We found,⁷ as an observation, that in general the Y-carbons (C_Y), which represent the internal carbons in the FAR region having a connectivity of three (see Figure 4), also provide information on the location of the resonant sextets in the perisection in PAHs and consequently in asphaltenes. We denominate these carbons as internal Y-carbons (C_Y) because they are in the vertex of what looks like a Y letter.⁷

Thus, we came up with a simple rule to draw the most likely localization of the resonant rings (Clar sextets) in peri-benzenoid polycyclic aromatic hydrocarbon compounds and in the fused ring region in asphaltenes. We have called it the Y-rule because it involves the Y-carbons. This rule has already been published;⁷ however, we state it again here for practical purposes.

The resonant sextets are located in the hexagons that contain the C_Y (Y-carbons). All of the C_Y carbons of the corresponding stoichiometry have to be included (i.e., covered by sextets). When there is more than one possibility to locate the sextets due to the arrangement of the internal Y-carbons, the possibility that provides the higher symmetry and the higher number of sextets will be the most probable. The structure must contain the highest number of resonant sextets possible.

The use of the Y-rule will be explained in detail in the following section. This rule has only been applied to planar and concave or distorted benzenoid peri-PAHs and to the perisection of the fused aromatic region in asphaltenes, and it cannot be used for catacondensed PAHs because there are no Y-carbons in these structures.

The Y-rule is based on topological information of the PAH system, and our observation has been supported by experimental NMR results. Iuliucci and co-workers⁵⁰ studied the ¹³C chemical shift tensor of perylene and concluded that the distribution of the π electrons is largely determined by the molecular connectivities.

Any PAH stoichiometry involves a certain number of resonant sextets in the structure; see Table 1. For example, for the stoichiometry $C_{28}H_{14}$, with eight isomers, the maximum number of Clar's resonance sextets is four (Table 1), and there are also two double bonds. However, not all of the eight $C_{28}H_{14}$ isomers (8FAR) have the maximum number of Clar's resonance sextets.

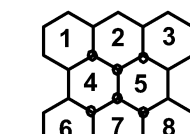
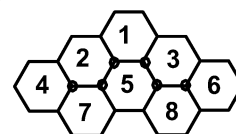
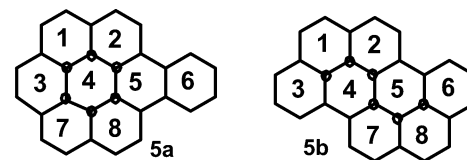

5c

5d

Clar Structures

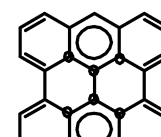
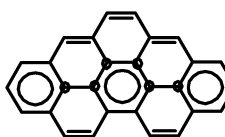
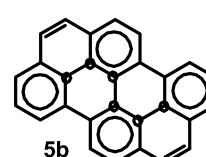
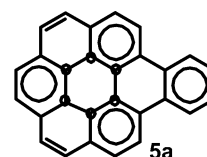

5c

5d

Figure 5. Structures of 8FAR systems with stoichiometry $C_{28}H_{14}$. The Y-carbons in each structure are circled. In the bottom part the Clar structure obtained with the Clar sextet principle as determined by the Y-rule for each isomer is drawn.

There will be isomers with four resonant sextets, three resonant sextets, two resonant sextets, or even one resonant sextet. So, the questions that arise are which of the eight isomers of $C_{28}H_{14}$ has four, three, two or even one resonant sextets? How is the π density most likely to be distributed (located) to be able to understand the tendencies of the HOMO–LUMO structural isomers? And in the case of large peri-PAHs, how is the π density distributed? What is or are the most important Clar structures that define the aromaticity of a particular large peri-PAH? The Y-rule helps to answer these questions in an easy way, as we will discuss in the next section.

3.2. Clar Structures and NICS for Peri-PAHs Isomers with Eight Fused Aromatic Rings (8FAR) and Highest Percentage of Compactness (75%). For 8FAR with the stoichiometry $C_{28}H_{14}$, there are eight isomers (Table 1). We only studied four of the isomers instead of the eight that exist (Table 1). However, the four calculated isomers are representative of the rest in terms of the number of resonant sextets. These 8FAR compounds with 89% of compactness can have four, three, and two resonant rings in their structure, Table 1. We have calculated one isomer for each case.

In Figure 5, the structures of the four isomers **5a**, **5b**, **5c**, and **5d** are presented. In this figure, the contour diagram given by all of the Y-carbons is highlighted in bold. In the upper part of Figure 5, the σ backbones of the isomers are drawn, whereas in the bottom part the π -density distribution obtained by the Clar sextet principle, as determined by the Y-rule, is presented. All of the isomers have the stoichiometry $C_{28}H_{14}$, eight fused

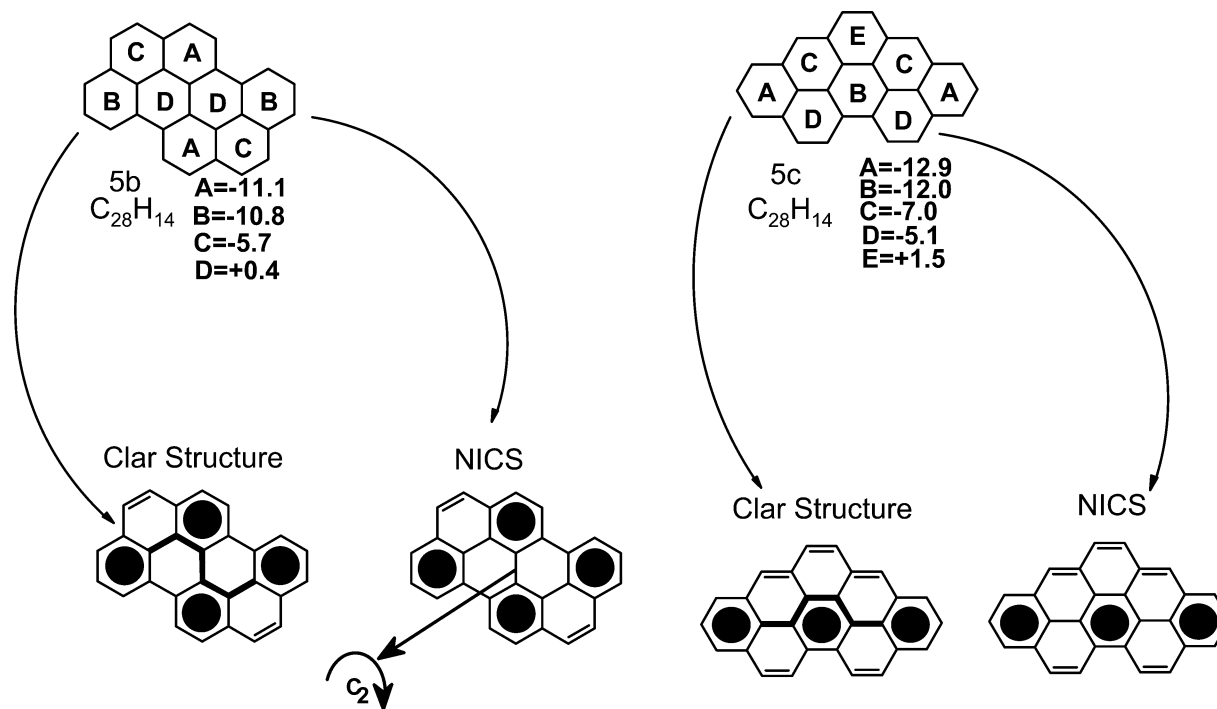

Figure 6. Clar structures obtained with the Clar sextet principle as determined by the Y-rule and calculated NICS(0) values for the 8FAR systems **5b** and **5c**, with 75% of compactness.

aromatic rings (8FAR), a percentage of compactness of 75%, 28 π electrons, and the total number of Y-carbons is six, $C_Y = 6$ (Table 1).

We shall now continue with an explanation, step by step, on how the Y-rule is applied. First of all, the Y-carbons are identified in the structure just by looking at the σ backbones. In Figure 5, the contour diagrams given by the Y-carbons are highlighted. Then, the resonant sextets are drawn in such a way that *all* the Y-carbons participate in resonant sextets. However, there are several possibilities to do this. It must be ensured that the chosen possibility gives the highest number of sextets that can possibly be drawn given the total π density available.

In the case of the C₂₈H₁₄ systems (Figure 5), there are 28 π electrons. Thus, the maximum number of sextets that can be formed with 28 π electrons and a percentage of compactness of 75% is four (Table 1). It is important to mention that PAH systems, of any *n*FAR family, with a percentage of compactness higher than 79% cannot present the maximum number of sextets given by the division of the total number of π electrons by six.⁷

Not all of the C₂₈H₁₄ isomers have the maximum number of Clar's resonance sextets. Due to the fact that the arrangement of the Y-carbons is different for each isomer, the final distribution of the π density in resonant sextets and double bonds is different for each isomer (Figure 5).

The target is to draw the sextets in each isomer always using all of the Y-carbons and trying to reach the highest possible number of resonant sextets without exceeding the valence of any carbon atom. Once the resonant sextets have been placed, the distribution of the π electrons is finished by placing the remaining π electrons in double bonds taking care to locate the double bonds without exceeding the valence of the carbon atoms.

We will start discussing the distribution of the π density in isomers **5b** and **5c** as the easiest cases. In the case of **5b** (Figure 5), there are three possibilities of placing the resonant sextets covering all of the Y-carbons and without exceeding the valence of any carbon atom. Two possibilities are to draw sextets in

hexagons 1 and 5 or in hexagons 4 and 8. However, both combinations only will provide a total of two resonant sextets and eight double bonds. The third possibility is to draw sextets in hexagons 2, 3, 6, and 7. This last possibility covers with sextets all of the Y-carbons and provides the highest possible number of resonant sextets in the structure (Table 1). Finally, the four remaining electrons (for a total of 28 π electrons) are placed in two double bonds located in hexagons 1 and 8 to fulfill all of the carbon atoms valencies. The final distribution of the π density for **5b** is shown at the bottom of Figure 5.

For **5c** (Figure 5), there is only one possibility of using all of the Y-carbons in resonant sextets without exceeding the valence of any carbon atom and that provides the highest possible reachable number of resonant sextets for this particular structure. This possibility requires placing resonant sextets in hexagons 4, 5, and 6. Any other possibility either would provide a lower number of resonant sextets or would exceed the valence of some carbon atoms. It is found that the highest reachable number of resonant sextets for this structure happens to be three and not four as was the case for **5b**. The final distribution of the π density for **5c** is shown at the bottom of Figure 5.

In the case of **5a**, there is a catacondensed region in the structure. This region involves the hexagon labeled as 6 (Figure 5). By application of the Y-rule to the periregion, which resembles the 7FAR coronene (**12b**), it is possible to use all of the Y-carbons by drawing only one resonant sextet occupying the hexagon labeled as 4, Figure 5. But this option does not provide a high number of resonant sextets. The other options are to draw three resonant sextets occupying the hexagons 1, 5, and 7 or 2, 3, and 8. The later option allows us to draw another resonant sextet in the cataregion (i.e., in the hexagon number 6) without overcoming the carbon atoms valence, for a total of four resonant sextets in the structure. Thus, this is the preferred distribution of the π density in **5a**, and its Clar structure is presented in the bottom part of Figure 5.

In **5d**, the six Y-carbons (C_Y) that define the Y-carbons contour are located in the central hexagons of each anthracene

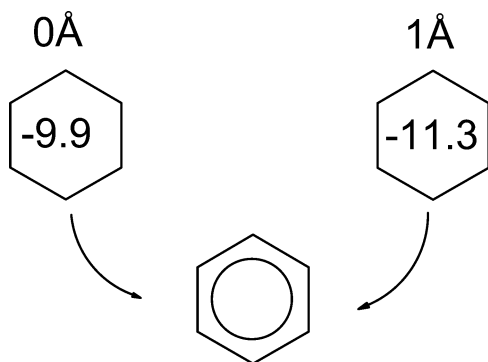

Figure 7. Total NICS for benzene calculated on the molecular plane at the geometrical center (0 Å), NICS(0), and at 1 Å above the molecular plane, NICS(1).

fragment, Figure 5. The only way to place resonant sextets and to use all of the Y-carbons at the same time without exceeding the valence of any carbon atom is by drawing one sextet in hexagon 2 and another sextet in hexagon 7 giving a total of two resonant sextets in this isomer (Figure 5). The remaining π density is located in double bonds. The final distribution of the π density in each 8FAR isomer obtained by using the Y-rule is presented at the bottom of Figure 5.

By use of the Y-rule to distribute the π density in the isomers **5a–5d**, we have found that the isomers **5a** and **5b** have a total of four resonant sextets whereas the isomers **5c** and **5d** have three and two resonant sextets, respectively.

We shall now analyze the results given by the NICS calculations and compare them with the π -density distribution obtained by the Clar sextet principle as determined by the Y-rule. In the top portion of Figure 6, the NICS values calculated for **5b** and **5c** are presented. The calculated NICS magnitude and the relative aromaticity are assessed by comparison with the NICS of benzene.^{11,18,32} The calculated NICS values for benzene are NICS(0) = -9.9 and NICS(1) = -11.3 (Figure 7).

The calculated total NICS values for **5b** and **5c** present values that are in some cases larger than those for benzene (Figure 7). A factor pointed out previously by Aihara⁵¹ that affects the calculated NICS value at several hexagons in PAHs is that ring currents induced in a PAH are a superposition of currents induced in all hexagons in the molecule. Thus, the analysis of local aromaticity in PAHs using NICS calculations becomes complicated in terms of all of the possible contributions.

However, from the total NICS values, as proposed by Schleyer^{11,18,32} (see Introduction), we could say that the hexagons labeled as A and B in **5b** and **5c** (Figure 6) contain the resonant sextets because their NICS values are the highest of all the hexagons. In the case of **5b**, the calculated total NICS for the A hexagons is equal to -11.1 ppm and NICS = -10.8 ppm for the B hexagons. The two A hexagons are related by symmetry, and also the two B hexagons, giving a total number of four resonant sextets, which occupy 24 π electrons of a total of 28 π electrons.

The remaining four π electrons are located in the hexagons labeled as C in two double bonds. The calculated NICS for the C hexagons (which are also related by symmetry) is equal to -5.7 , which is negative, meaning that there is π density present in these hexagons but it is much smaller than the NICS of benzene, -9.9 (see Figure 7). Thus, we could say that there is a localized double bond in each of the C hexagons and that the π electrons in these C hexagons do not participate in resonant sextets (i.e., they behave more like olefins).

TABLE 2: Calculated Total NICS(0), Total NICS(1) and Total Components to NICS for Benzene (numbers in ppm)

calc. type	NICS ^a	NICS _⊥ ^b	total NICS ^c	NICS anisotropy ^d Δ NICS
NICS(0)	-7.7	-14.5	-9.9	-6.8
NICS(1)	-2.4	-29.1	-11.3	-26.7
Total Diamagnetic Contribution (ppm) ^e				
NICS(0)	-25.3	-44.7	-31.8	-19.4
NICS(1)	-4.8	-33.9	-14.5	-29.1
Total Paramagnetic Contribution (ppm) ^e				
NICS(0)	17.6	30.3	21.9	12.7
NICS(1)	2.4	4.8	3.2	2.4

^a NICS_{||} = $-(\sigma_{xx} + \sigma_{yy})/2$. ^b NICS_⊥ = $-\sigma_{zz}$. ^c NICS = $(2/3)$ NICS_{||} + $(1/3)$ NICS_⊥. ^d Δ NICS = NICS_⊥ - NICS_{||}. ^e NICS_{⊥off} = NICS_{⊥off}^d - NICS_{⊥off}^p.

The C hexagons in **5b** do not possess an ideal ring current in the π system, and the paramagnetic contribution does not vanish, as it does in the case of benzene, and the total NICS is smaller (-5.7) than that of benzene (-9.9) because the paramagnetic contribution overcomes the diamagnetic contribution in the shielding tensor perpendicular to the molecular plane σ_{\perp} .

As explained in the Introduction, the NICS is defined as the negative value of the absolute isotropic magnetic shielding according to eq 1.

$$\text{NICS} = -\sigma_{\text{isotropic}} = -\left(\frac{1}{3}\sigma_{\perp} + \frac{2}{3}\sigma_{\parallel}\right) = \frac{1}{3}\text{NICS}_{\perp} + \frac{2}{3}\text{NICS}_{\parallel} \quad (1)$$

The two components of the isotropic chemical shift, $\sigma_{\text{isotropic}}$, are the shielding tensor perpendicular to the molecular plane (σ_{\perp}) and the shielding tensor parallel to the molecular plane (σ_{\parallel}). In the case of benzene, the delocalized six resonant π electrons (Figure 2) are located in molecular orbitals (MOs) perpendicular to the molecular plane, which are pure π type. Thus, the shielding tensor perpendicular to the molecular plane (σ_{\perp}) is indicative of the π -induced ring current.

For all of the PAHs systems calculated here, the total contribution to NICS of the component parallel to the molecular plane NICS_{||} (in-plane component, see eq 1) is dominated mainly by a negative diamagnetic contribution, which is almost constant (-9 to -10 ppm) for all of the hexagons in all of the systems and higher than the NICS_{||} calculated for benzene (-7.7 ppm), see Table 2.

The total NICS component perpendicular to the molecular plane NICS_⊥ (out-of-plane component, see eq 1) changes considerably in all of the systems, and in a few cases it is dominated by a positive paramagnetic contribution. In some cases, the perpendicular component, NICS_⊥, is higher than the value calculated for benzene (-14.5 ppm).

The component of the isotropic chemical shielding perpendicular to the molecular plane, σ_{\perp} (eq 1), can be written as a sum of a diamagnetic contribution, $\sigma_{\perp}^{\text{d}}$, and a paramagnetic contribution, $\sigma_{\perp}^{\text{p}}$, according to eq 2. The diamagnetic contribution, $\sigma_{\perp}^{\text{d}}$, which is negative in the NICS convention, stems from the circulation of ground-state density (diatropic or diamagnetic current) that originated from the coupling of occupied C–C(π) and C–H molecular orbitals by the applied magnetic field.^{33,40,41,52,53} However, the paramagnetic contribution, $\sigma_{\perp}^{\text{p}}$, which is positive in the NICS convention, stems from the circulation of current density (paratropic or paramagnetic current) that originated from the coupling of occupied and virtual C–C(σ) molecular orbitals by the applied magnetic field.^{33,40,41,52,53}

$$\text{NICS}_{\perp} = -\sigma_{\perp} = -(\sigma_{\perp}^{\text{d}} + \sigma_{\perp}^{\text{p}}) = \text{NICS}_{\perp}^{\text{d}} + \text{NICS}_{\perp}^{\text{p}} \quad (2)$$

In benzene, where there is an ideal ring current in the π system, the paramagnetic contribution in eq 2 vanishes ($\sigma_{\perp}^p = 0$) for symmetry reasons, since the π MOs are eigenfunctions of the angular momentum operator L_z along the 6-fold molecular axis (i.e., $\langle \pi_x | \hat{M}_z | \pi_x^* \rangle = \langle \pi_x | \pi_x^* \rangle = 0$ and $\langle \pi_y | \hat{M}_z | \pi_y^* \rangle = \langle \pi_y | \pi_y^* \rangle = 0$).

Thus, for benzene, the π contribution to σ_{\perp} consists of a diamagnetic part only according to eq 3.^{11,33,48}

$$\text{NICS}_{\pi \text{ density}} = -\sigma_{\perp}^d \quad (3)$$

The resulting uniquely large diatropic total $\text{NICS}(0) = -9.9$ denotes the aromaticity of benzene, which is consistent with the current density circulations, diatropic for C–C(π) and C–H, but paratropic for C–C(σ), shown by Fowler and others.^{41,52,53} By dissection of the NICS values (i.e., calculating independently the σ and π contributions to the chemical shift),⁴⁰ the size dependence of the calculated NICS values for benzene can be overcome. Schleyer et al.⁴¹ showed, by dissections of NICS points above the benzene ring center, that the paratropic C–C(σ) curve drops off more rapidly than the diatropic C–C(π) rises. Consequently, $\text{NICS}_{\text{total}}$ is diatropic. Thus, the ring current model for benzene is limited to the π contribution to σ_{\perp} .

However, for systems that do not possess an ideal ring current in the π -system, as it is in the case of benzenoid peripolycyclic aromatic hydrocarbons (peri-PAHs), whose π density is described by the resonant sextet–double bond distribution, the paramagnetic contribution does not vanish, and the total NICS can become positive if the paramagnetic contribution overcomes the diamagnetic contribution. In the hexagons that contain only one or two *localized* double bonds instead of three *unlocalized* double bonds (as is the case in the resonant sextet), the ring current of π MOs is partially destroyed, and the assumption of a freely rotating π stream, for MOs that are eigenfunctions of L_z along the molecular axis, is much less justified.³³

The ideal ring current concept advocates delocalization of π electrons as the basic physical fact that determines special mobility in the presence of a magnetic field perpendicular to the magnetic plane and, consequently, the existence of intense stationary currents, which are responsible for the enhanced magnitude of the diamagnetic contributions to the perpendicular of the magnetic tensors.⁵⁴

As explained above, the C hexagons in **5b** do not possess an ideal ring current in the π system, and because of this the paramagnetic contribution does not vanish and overcomes the diamagnetic contribution in the component perpendicular to the molecular plane, σ_{\perp} , giving as a result a $\text{NICS}_{\perp} = 4.9$ and a total NICS of -5.7 , which is much smaller than the total NICS of benzene (-9.9), Figure 7. In the case of benzene, the total diamagnetic contribution to $\text{NICS}(0)$ and $\text{NICS}(1)$, which includes the C–C(π) and C–H contributions, see Table 2, always overcomes the paramagnetic contribution, which includes the C–C(σ) contributions.

The hexagons labeled as D in **5b** present a NICS value which is positive, $\text{NICS} = +0.4$ ppm. According to Schleyer,³² a positive NICS value denotes antiaromaticity. However, the value of $+0.4$ is too small and near to zero to consider antiaromaticity, and there are no more π electrons to be accommodated in the D hexagons. Thus, we consider that actually the D hexagons are empty rings. The empty ring concept, introduced by Clar,^{8,9} implies that the π electrons are not in conjugation within that ring.

The picture of the distribution of the π density obtained from the NICS analysis of **5b** agrees with the distribution of the π

density obtained with the Clar sextet principle as determined by the Y-rule (Figure 5 and 6). Both electronic distributions also agree in the fact that there is no π density in the D hexagons.

In the case of **5c**, the highest NICS values are observed in hexagons labeled as A and B. The NICS values are -12.9 and -12.0 , respectively. These values are larger than that of benzene $\text{NICS}(0) = -9.9$. Thus, we consider that the A and B hexagons present resonant sextets, giving a total of three resonant sextets, which involve 18 π electrons. The remaining 10 π electrons are distributed in five double bonds in the remaining hexagons. The double bonds are in the C and D hexagons, which present a NICS value of -7.0 and -5.1 ppm. These hexagons present negative and aromatic NICS values that are smaller than the value of benzene, which makes us conclude that there are no resonant rings in these hexagons. When distributing the double bonds, taking care not to exceed the valence of any of the carbon atoms, it is only possible to locate one double bond in the C and D hexagons for a total of eight π electrons. The remaining double bond should be in the E hexagon. The NICS in the E hexagon is positive, $+1.5$, meaning that the two π electrons located in this hexagon behave as antiaromatic, following Schreyer's convention.^{18,32}

The picture of the distribution of the π density obtained from the NICS analysis of **5c** agrees with the distribution of the π density obtained with the Clar sextet principle as determined by the Y-rule (Figure 5 and 6).

In Figure 8, the calculated $\text{NICS}(0)$ results for **5a** are given. By looking at the results, we would say that all of the hexagons are aromatic, following Schleyer's convention,^{18,32} because all of the calculated NICS values are negative. However, the central F hexagon presents a NICS value almost equal to zero, which means that there is no aromaticity in this hexagon. Thus, we could conclude that there is no π -electronic density present in this hexagon.

The total NICS has two components (eq 1), the perpendicular component to the molecular plane, NICS_{\perp} , and the parallel component to the molecular plane, NICS_{\parallel} . The calculated perpendicular component, NICS_{\perp} , for the F hexagon is composed of a large positive paramagnetic contribution (21.5 ppm).

The high-paramagnetic contribution cannot be raised by local density in the F hexagon, but it mostly arises from the adjacent hexagons surrounding the F hexagon, A, D, B, and E, which have a high-negative NICS (Figure 8) dominated by a diamagnetic contribution.

When a molecule is placed into a homogeneous static magnetic field, a current density is induced. This current density induces additional fields at the position of the nuclei being tested. If such an additional field weakens the applied external field, one finds shielding (high field shift); if it strengthens the field, deshielding (downfield shift) is realized. At the center of the ring current, a diamagnetic current or diatropic current around a nucleus causes shielding, and a paramagnetic current or paratropic current causes deshielding. With an increase of distance between the nucleus and the center of the ring current, the effect decreases, and it even changes its sign for a large enough distance.

The situation is presented in Figure 9. The perpendicular diamagnetic shielding, σ_{\perp}^d (eq 2), in hexagons A, D, B, and E in **5a** stems from a circulation of the ground-state density (\vec{J}_d) around the atom probe induced by the applied magnetic field, \vec{B}_0 . The circulation results in an induced magnetic field, \vec{B}_{ind}^d , which is opposite in direction to \vec{B}_0 . The corresponding shielding, σ_{\perp}^d , is as a consequence positive, and NICS_{\perp}^d is

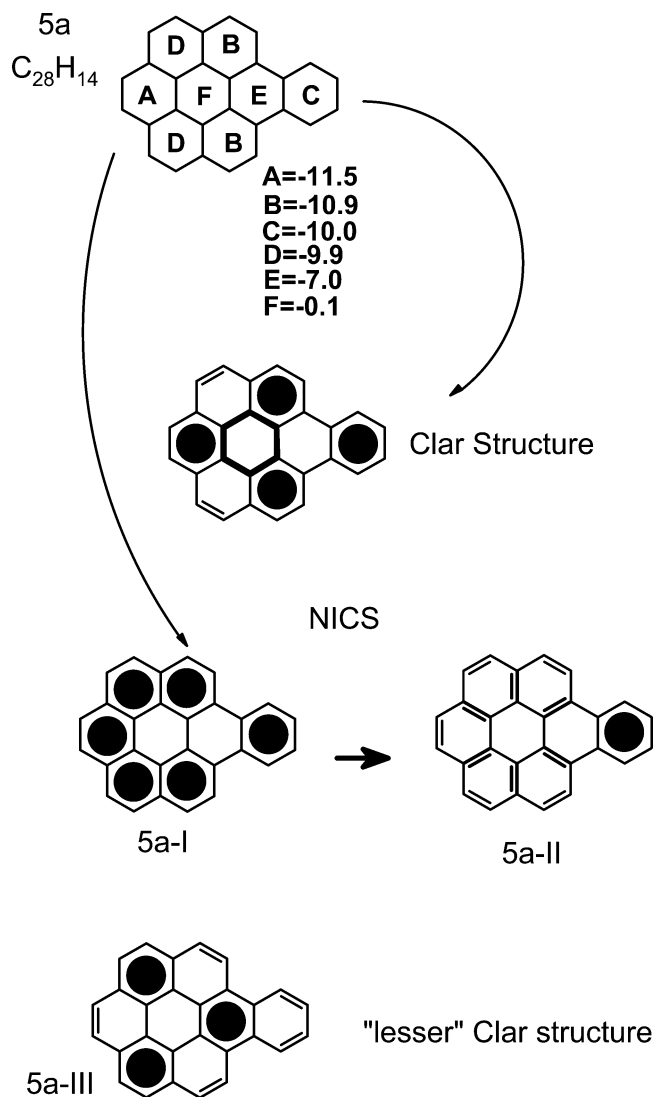

Figure 8. Clar structure obtained with the Clar sextet principle as determined by the Y-rule and calculated NICS(0) values for the 8FAR system **5a** (benzocoronene), with 75% of compactness. The "lesser" Clar structure at the bottom (**5a-III**) was proposed by Clar.⁹ (See text.)

negative (eqs 1 and 2). However, the resulting magnetic field, \vec{B}_{ind}^d , is parallel to \vec{B}_o "outside" the loop of the current density \vec{J}_d , and the corresponding shielding σ_{\perp}^d outside the hexagon is as a consequence negative and NICS_⊥^d is positive (eqs 1 and 2).

The effect of a diatropic π current outside a tested hexagon in PAHs is to produce a positive (paratropic) contribution to the NICS of the tested hexagon. The effect of a paratropic π current outside a tested hexagon in PAHs is to produce a negative (diatropic) contribution to the NICS of the tested hexagon.

The F hexagon in **5a** (Figure 8) is outside the diatropic current loops of the surrounding hexagons (A, D, B, and E), and thus the effect of the diamagnetic shielding in these hexagons on the F hexagon is to produce a high positive contribution to its perpendicular component NICS_⊥ = 21.5 ppm, which in turn gives as a result a total NICS close to zero (NICS = -0.1).

In **5a**, the highest NICS values are calculated for hexagons A, B, C, and D, NICS = -9.9 ppm to -11.5 ppm, Figure 8. We consider that there is a resonant sextet in the C hexagon whose NICS (-10.0) is close to the calculated NICS of benzene (-9.9). Also, we would say that there is a resonant sextet on each A, B, and D hexagons just by looking at their total NICS

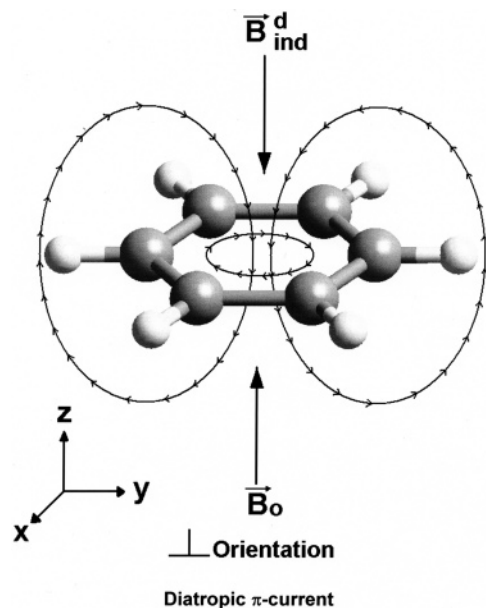

Figure 9. Schematic representation for the effect of an induced magnetic field at the position of a ghost atom (dummy atom) inside the benzene ring and at positions outside the benzene ring.

value (**5a-I**, Figure 8). However, it is not possible to have resonant sextets simultaneously in all of these hexagons without exceeding the valence of most of the carbon atoms involved. Actually in **5a**, we have the same situation as in coronene (**12b**). The π -electronic distribution in coronene (**12b**) is discussed in detail below. In all of the hexagons external to the F hexagon, there is a double bond right at the junctions, thus the π density cannot be associated to a particular hexagon from a NICS calculation; see **5a-II** in Figure 8. We call this situation the "naphthalenic effect" because naphthalene is the smallest PAH where a double bond at the junction of the two hexagons is present.

The calculated NICS value for the E hexagon is smaller (-7.0) than that of benzene (-9.9). There is actually no π density located in this ring because all of the π -available (28 π electrons) density has already been distributed in hexagons labeled A to D. Thus, hexagons F and E are "empty hexagons".

The π -electronic distribution in **5a** provided by the NICS calculation is given in **5a-II**, Figure 8. The NICS π -electronic distribution agrees with the π -electronic distribution obtained using the Y-rule, Figures 5 and 8. Clar⁹ proposed the "lesser" Clar structure (**5a-III**) for benzocoronene (**5a**) in order to account for some observed chemical behavior that parallels the behavior of coronene (**12b**). However, neither the π -electronic distribution obtained with the Clar sextet principle as determined by the Y-rule nor the NICS calculation of **5a** agrees with the Clar structure **5a-III** proposed by Clar.⁹

In Figure 10, the results from the NICS calculation for the system **5d** are presented along with the π -electronic distribution obtained from the NICS analysis and the use of the Y-rule. The system **5d** represents a major difficulty in the total NICS analysis. From Figure 10, it can be concluded that the hexagons labeled as C are empty rings because their NICS value is very different from the NICS value of benzene (-9.9) and positive, +5.7 ppm. Hexagons A and B are related by symmetry, and thus their NICS values are identical. Hexagons C are also related by symmetry.

In the **5d** system, there are 28 π electrons. The highest NICS values correspond to hexagons A and B; however, these values are much smaller (-5.2 to -5.7) than the benzene value (-9.9).

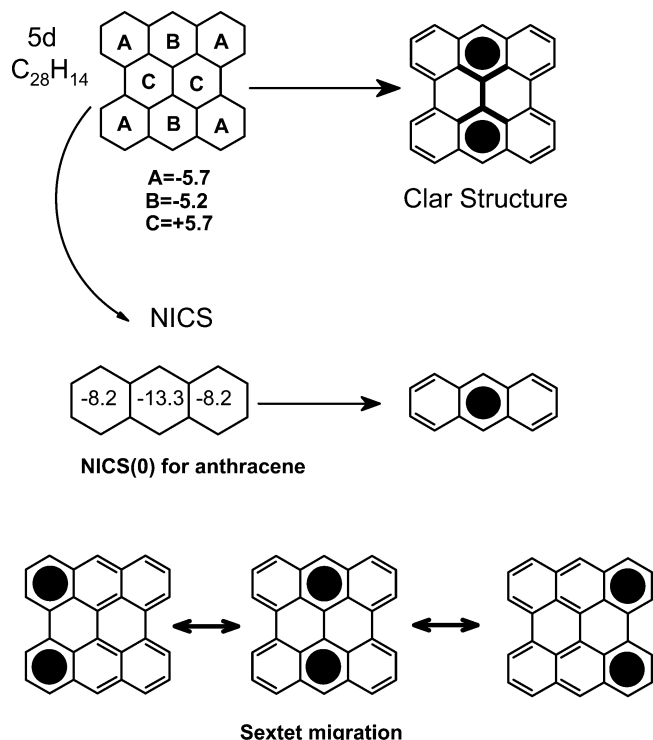

Figure 10. Clar structure obtained with the Clar sextet principle as determined by the Y-rule and calculated NICS(0) values for the 8FAR system **5d**, with 75% compactness.

Just by consideration of the total calculated NICS values (Figure 10), it is not possible to decide where the resonant sextets are located. The distribution of π density in the A hexagons has to be the same as well as the distribution in the B hexagons; otherwise the NICS values of the A or the B hexagons would not be the same.

Only the full resonant structures or polybenzenoid hydrocarbons (structures with only resonant sextets and no double bonds) show the extreme NICS values and similar to benzene value, as we will see later, whereas PAHs that are not full resonant show intermediate NICS values for several rings.^{18,32} In these cases, we found, by comparing with the π -electronic distribution obtained by the Clar sextet principle (or model) as determined by the Y-rule, that the highest NICS value obtained in the entire structure should be taken as reference to locate the sextets instead of by comparison with the NICS of benzene.

If we consider that there is a resonant sextet in each A hexagon, which has the highest NICS value, it is not possible to distribute the remaining 4 π electrons in the B hexagons without exceeding the valence of some carbon atoms. Thus, the resonant sextets must be then located in the B hexagons, giving a total of only two resonant sextets in the molecule and eight double bonds distributed in the A hexagons.

5d and perylene (**14a**) can be considered to be members of a group. **5d** has two anthracene fragments and **14a** has two naphthalene fragments. It is reported in the literature that in perylene (**14a**) the π density is located in the naphthalene fragments and distributed in the same way as in naphthalene.⁵⁰ **5d** and perylene (**14a**) represent examples of "essentially disconnected benzenoids" defined by Gutman et al.⁵⁵ Thus, we consider that in the case of **5d** the two resonant rings will also be located in the polyacene fragments and in the same way as in anthracene. It is reported that anthracene has only one resonant sextet located in the central hexagon.^{32,56}

The calculated NICS(0) for naphthalene and anthracene has been reported by Schleyer.³² For naphthalene, $NICS(0) = -9.9$

TABLE 3: NICS of 8FAR Systems Calculated at the Geometrical Center on the Molecular Plane (0 Å) and at 1 Å above the Molecular Plane

system	hexagon label	total NICS (ppm)	
		0 Å	1 Å
5a	A	-11.5	-13.3
	B	-10.9	-12.9
	C	-10.0	-11.7
	D	-9.9	-12.1
	E	-7.0	-10.0
	F	-0.1	-4.8
5b	A	-11.1	-13.0
	B	-10.8	-12.5
	C	-5.7	-8.4
	D	+0.4	-4.0
5c	A	-12.9	-14.3
	B	-12.0	-14.0
	C	-7.0	-9.8
	D	-5.1	-8.2
	E	+1.5	+2.3
5d	A	-5.7	-8.2
	B	-5.2	-8.1
	C	+5.7	+0.5

ppm for both hexagons, whereas $NICS(0) = -13.3$ ppm has been reported for the internal hexagon in anthracene and $NICS(0) = -8.2$ ppm for the two external hexagons³² (Figure 10). Thus, the NICS(0) calculation of anthracene shows that there is only one resonant sextet that is located in the central ring. Because of this, we conclude that the two resonant sextets in **5d** are in the hexagons labeled as B, which are the central rings of the anthracene fragments. The remaining π density is distributed in the other four remaining A hexagons.

The NICS values of the B hexagons in **5d** are slightly smaller (-5.2) than the NICS values of the A hexagons (-5.7). It could be argued that there is actually a movement or migration of the two resonant sextets along each polyacene fragment in **5d** generating a further ring current or resonant sextet migration current. This situation is represented at the bottom part of Figure 10. However, the resonant sextets are located in the B hexagons of the anthracene fragments most of the time. The decrease in the total NICS values in the B hexagons is due to the ring currents generated in the adjacent A hexagons where a diamagnetic current is created but felt as a paramagnetic current in the adjacent B hexagons as explained above. If we consider that **5d** is constructed by the union of two anthracene fragments, then the NICS picture of the aromaticity in each fragment agrees with the π -electronic distribution obtained by the Clar sextet principle as determined by the Y-rule for **5d**.

All of the NICS analyses for **5a–5d** correspond to NICS(0). The calculated NICS(1) at 1 Å above the molecular plane, where the π -electron ring current effects are dominant and the σ bonding contributions are diminished,^{40,41} are presented in Table 3. As can be seen in Table 3, the NICS(1) values are larger than the NICS(0) values; however, the tendencies and differences among all of the hexagons are conserved.

The following analysis of the calculated NICS and the use of the Y-rule for all of the other systems studied in this paper is carried out as explained in detail above. Thus, from now on, only the discussion of very specific difficult cases will be detailed.

3.3. Clar Structures and NICS for Peri-PAHs Isomers with Nine Fused Aromatic Rings (9FAR) and Highest Percentage of Compactness (89%). In Figure 11, the π distribution obtained with the Clar sextet principle as determined by the Y-rule for the three 9FAR isomers (Table 1) with the

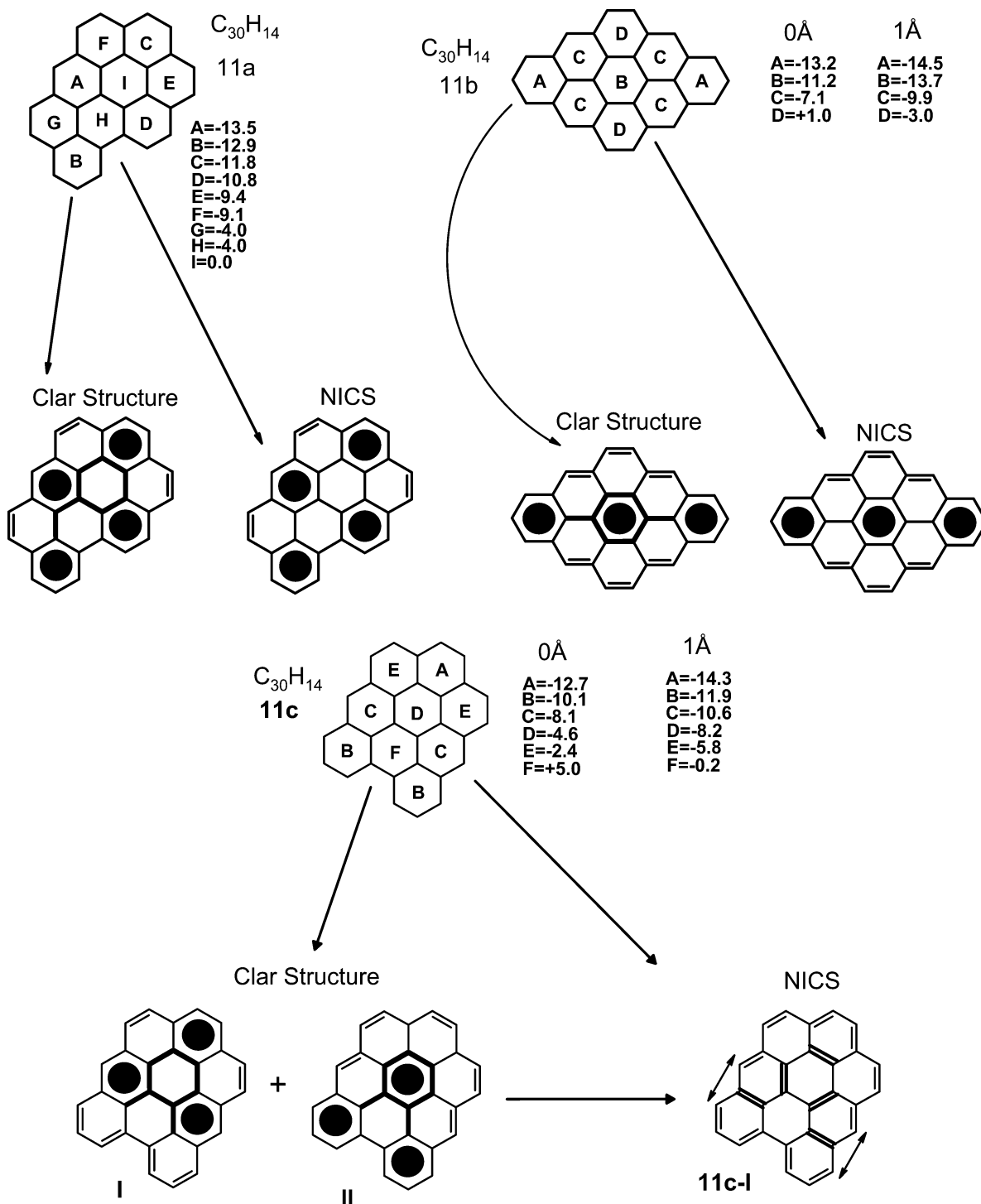

Figure 11. Clar structures obtained with the Clar sextet principle as determined by the Y-rule and calculated NICS(0) and NICS(1) values for the 9FAR system **11a**, **11b**, and **11c** with 89% compactness.

highest percentage of compactness (89%) are presented as well as their calculated NICS(0) values. The three isomers named **11a**, **11b**, and **11c** have a $C_{30}H_{14}$ stoichiometry and 30 π electrons to be distributed in sextets and double bonds. These three isomers have a total of eight Y-carbons (Table 1 and sections 3.1 and 3.2).

In the upper part of Figure 11, the σ backbone of **11a** is presented. The $C_{30}H_{14}$ stoichiometry can accommodate four, three, or two resonant sextets (N_R) and three, six, or nine double bonds, respectively, Table 1. Although the total number of π electrons in this stoichiometry is divisible by 6, these isomers (**11a**, **11b**, and **11c**) cannot be full resonant structures (FRS,

structures that only present resonant sextets and no double bonds) or reach the highest N_R because their percentage of compactness, P_C , is higher than 79%. This situation is observed from 7FAR on.⁷

The eight Y-carbons in **11a** are highlighted in Figure 11. By applying the Y-rule, we find that **11a** has a maximum of four resonant sextets, which is the highest number of resonant sextets that can possibly be reached by the $C_{30}H_{14}$ stoichiometry. The resonant sextets are located in the A, B, C, and D hexagons. The distribution of the resonant sextets in these hexagons ensures that all of the Y-carbons are covered by sextets and also that a high number of resonant sextets is reached.

The remaining six π electrons are distributed in three double bonds and are located in the hexagons labeled as E, F, and G. The double bonds cannot be placed in the H and I hexagons because the surrounding resonant sextets have already fulfilled the valence of the carbon atoms. Thus, the H and I hexagons are actually empty rings. The final Clar structure thus obtained is presented at the bottom part of Figure 11.

The highest calculated NICS values for **11a** (Figure 11) correspond to the hexagons A–D with values oscillating from -13.5 to -10.8 ppm. Thus, we consider that the resonant sextets would be located in these hexagons giving a total of four resonant sextets. The total NICS for these hexagons is larger than the NICS for benzene (-9.9). This is due to the effect of ring currents generated in the adjacent neighbors that also contain π density (Figure 9 and related text).

The E hexagon and the F hexagon present a NICS value smaller than the NICS of benzene (-9.9), -9.4 and -9.1 ppm, respectively. This is due to two factors. First, the presence of the ring currents generated in the adjacent hexagons (A, C, and D) where a diatropic current is created and felt as a paratropic current at the position of the E hexagon and F hexagons (see Figure 9 and related text). However, the ring current generated in the E hexagon and F hexagons is not diatropic enough to overcome the paramagnetic contributions. Thus, we could conclude that there is not ideal ring current (see section 3.2) in the π system in the E and F hexagons but there is a double bond in each ring.

The I hexagon presents a calculated NICS value equal to zero. Thus, we conclude that actually this ring is an empty ring. The remaining two π electrons are located as a double bond in either the G or the H hexagons. Both hexagons present a calculated NICS value of -4.0 ppm. The double bond actually cannot be located in the H hexagon without overcoming the valence of carbon atoms. All of the carbon atoms that compose the H hexagon have their valence completed due to the presence of resonant sextets in the A, B, and D hexagons. Thus, the remaining double bond must be located in the G hexagon. The G hexagon is surrounded by the A, B, and H hexagons. We cannot say why the G hexagon presents a NICS value similar to the NICS value of the H hexagon (-4.0).

The π -density distribution obtained with the NICS calculation is presented in Figure 11. As can be seen, the Clar structure obtained with the Clar sextet principle as determined by the Y-rule and the NICS analysis are identical.

The σ backbone of **11b** as well as the π -electronic distributions obtained by the Clar sextet principle and the NICS calculation are presented in Figure 11. The eight Y-carbons in **11b** are highlighted in Figure 11. By application of the Y-rule, we find that **11b** has a maximum of three resonant sextets instead of four, as in the case of **11a**. The resonant sextets are located in the A and B hexagons. The distribution of the resonant sextets in these hexagons ensures that all of the Y-carbons are covered by sextets and that the highest possible number of resonant sextets is reached for this particular spatial distribution of the nine hexagons. None of the carbon atoms valencies is overcome. The remaining 12 π electrons are distributed in six double bonds that are located in the remaining hexagons (C and D). The final Clar structure thus obtained is presented at the middle part of Figure 11.

The highest calculated NICS(0) values for **11b** (Figure 11) correspond to the A hexagons and the B hexagon, -13.2 and -11.2 ppm, respectively. Thus, we consider that the resonant sextets are to be located in these hexagons, giving a total of three resonant sextets. The total NICS(0) for these hexagons is

larger than the NICS(0) for benzene (-9.9). This is again due to the effect of ring currents generated in the adjacent hexagons that also contain π density (Figure 9).

The C hexagons present a NICS(0) value smaller than the NICS(0) of benzene (-9.9), -7.1 ppm. Again this may be due to two factors, (1) the diatropic ring currents generated in the adjacent hexagons (A and B) felt as a paratropic current in the C hexagons (see Figure 9 and related text) and (2) the ring current generated in the C hexagon is not diatropic enough to overcome the paramagnetic current generated within these C hexagons. Thus, we conclude that there is not an ideal ring current in the π system in the C hexagons but there is a double bond in each ring. There cannot be more than one double bond in these rings without overcoming the carbon atoms valencies.

The D hexagons present a calculated NICS(0) value that is positive ($+1.0$). We could conclude that actually this ring is an empty ring. However, we still have four π electrons to be accommodated, and they must be located in these D hexagons, see Figure 11.

The calculated NICS(1) at 1 \AA above the molecular plane, where the π -electron ring current effects are dominant and the local σ bonding contributions are diminished,^{18,40,41} are also given in Figure 11 for **11b**. The NICS(1) of the D hexagons is negative but small (-3.0). It is not clear why. It could be also the effect of the currents generated in the adjacent hexagons.

The π -density distribution obtained with the NICS calculations for **11b** is presented in Figure 11. As can be seen, the Clar structure obtained by applying the Y-rule and the NICS analysis are in agreement. However, for this case (**11b**) the information obtained from the NICS calculation can only be used to elucidate where the resonant sextets are located, but the distribution of the double bonds is complicated.

The third isomer of the $\text{C}_{30}\text{H}_{14}$ stoichiometry is the **11c** compound. The σ backbone and the π -electronic distribution for this system (Clar structure and NICS) are presented in Figure 11. By application of the Y-rule, we obtain that in **11c** there are two distributions of the π density, named **I** and **II** (Figure 11). The π -electronic density is located in three resonant sextets and six double bonds in both distributions. The resonant sextets in **I** are located in the A and C hexagons, whereas in **II** they are located in the B and D hexagons.

The highest NICS(0) values are calculated to be in the hexagons A, B, and C (**11c**, Figure 11), with a NICS(0) = -12.7 , -10.1 , and -8.1 ppm, respectively. The difference between NICS(0) for hexagons B and C is 2 ppm. We also calculated the NICS(1) for **11c** at 1 \AA above the molecular plane. The highest NICS(1) values are again calculated to be in the hexagons A, B, and C, but the difference between the NICS(1) for hexagons B and C is smaller (1.3 ppm). The NICS(1) values in the B hexagon and C hexagon are -11.9 and -10.6 , respectively.

The calculated NICS(1) for the C hexagon resembles that of benzene (-11.3 , see Table 2). We could say that there is a shared double bond at the junction of the B and C hexagons, which makes it difficult to assign the resonant sextet to a particular hexagon. It could happen that the resonant sextet in the B hexagon migrates into the neighboring C hexagon as depicted in **11c-I** (Figure 11).

The NICS(1) for the D hexagon is high, which means that there is also sharing of a double bond between the D hexagons and each of the C hexagons and between the D hexagon and the A hexagon, as shown in **11c-I**; see Figure 11. However, the π electrons of the double bond at the junction of the A–D hexagons become conjugated in the A hexagon, when an

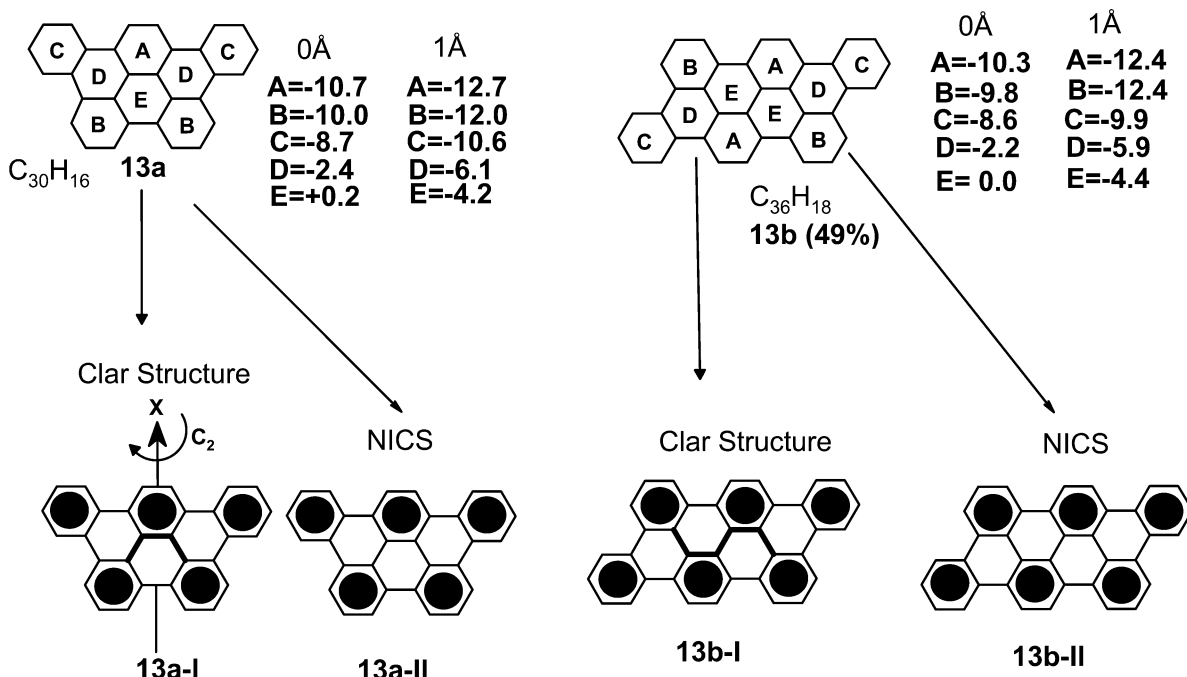

Figure 13. Clar structures obtained with the Clar sextet principle as determined by the Y-rule and calculated NICS(0) and NICS(1) values for full resonant PAHs with 8FAR (**13a**) and 10FAR (**13b**).

external magnetic field is applied, and because of this the A hexagon NICS values are higher than the NICS value of the D hexagon.

The smallest calculated NICS(0) and NICS(1) values correspond to the F hexagon and most likely correspond to an empty ring. The remaining π density (four π electrons) is placed as double bonds in the E hexagons (see **11c–I** in Figure 11).

As it can be seen in Figure 11, the distribution of the π -electronic density given by the NICS values, **11c–I** (Figure 11), is similar to the pictorial sum, or superposition, of the two Clar structures determined by the Y-rule, named **I** and **II** (Figure 11).

3.4. Clar Structures and NICS for Peri-PAHs Isomers with 100% Compactness. In Figure 12, the total NICS for four circular PAHs with a percentage of compactness of 100% are presented. These systems are pyrene (**12a**), coronene (**12b**), ovalene (**12c**), and **12d** with 4, 7, 10, and 14 fused aromatic rings, respectively (4FAR, 7FAR, 10FAR, and 14FAR).

The 4FAR compound corresponds to pyrene (**12a**), $C_{16}H_{10}$, which has 16 π electrons. The 7FAR compound corresponds to coronene (**7c**), $C_{24}H_{12}$, which has 24 π electrons. The 10FAR compound corresponds to ovalene (**12c**) with 10 fused aromatic rings, a $C_{32}H_{14}$ stoichiometry, and 32 π electrons. The 14FAR compound (**12d**), $C_{42}H_{16}$, has 42 π electrons. The PAH stoichiometries with 100% of compactness only present one isomer. Thus these isomers (**12a**, **12b**, **12c**, and **12d**) will have the highest possible reachable number of resonant sextets (Table 1).

For the case of pyrene (**12a**), there are two Y-carbons, which are highlighted in bold in Figure 12. Pyrene (**12a**) has 16 π electrons in total; thus it only can present two resonant sextets, as a maximum number, and two double bonds. The only way to place two sextets in the pyrene σ frame (Figure 12) using both Y-carbons and without overcoming any carbon atom valence is by placing each sextet in the A hexagons. The NICS(0) value calculated for the A hexagons is the highest, -12.8 ppm. The remaining four π electrons are located as double bonds

in the B hexagons. The NICS value calculated for the B hexagons is much smaller (-5.6 ppm) than the NICS value of the A hexagons (-12.8 ppm) and much smaller than the NICS value of benzene (-9.9 ppm), confirming that there are no resonant sextets present in these hexagons. The π -electron distribution obtained with the Clar sextet principle as determined by the Y-rule agrees with the one obtained with the NICS calculation. The calculation time necessary to calculate the NICS of a small system like pyrene is not a problem. However, as the systems get larger, the computing time increases drastically.

For the case of **12b**, the Y-rule gives two Clar structures named **I** and **II** (Figure 12). These distributions have three resonant sextets and three double bonds each. If the distinction of different hexagons in **12b** is not made, then the distributions **I** and **II** are the same and related by a symmetry operation. The symmetry of each distribution is D_{3h} .

In the case of pure perisystems, the highest number of resonant rings that can be present in the structure is related to the percentage of compactness or condensation.⁷ Because of this, coronene ($P_C = 100\%$) only has three resonant sextets although it has 24 π electrons in the structure. From 7FAR on, the highest number of resonant sextets, N_R , given by the division of the total number of π electrons by 6, cannot be reached if the structure has a percentage of compactness greater than or equal to 79% ($P_C \geq 79\%$). In this case, only $N_R - 1$ can be reached.

The total computed NICSs for all of the external A hexagons (**12b**, Figure 12) have the same value and are aromatic. The internal B hexagon is also calculated to be aromatic. However, there is no resonant sextet located in this hexagon because the NICS(0) value is almost zero. The distribution of the π -electronic density given by the NICS values, named **III**, is presented in Figure 12. In the **III** distribution, all of the external rings are equal. The symmetry of **III** is D_{6h} . In all of the external hexagons, there is a double bond right at the junctions; thus the π density cannot be associated to a particular hexagon. It is interesting to notice that the distribution of the π -electronic

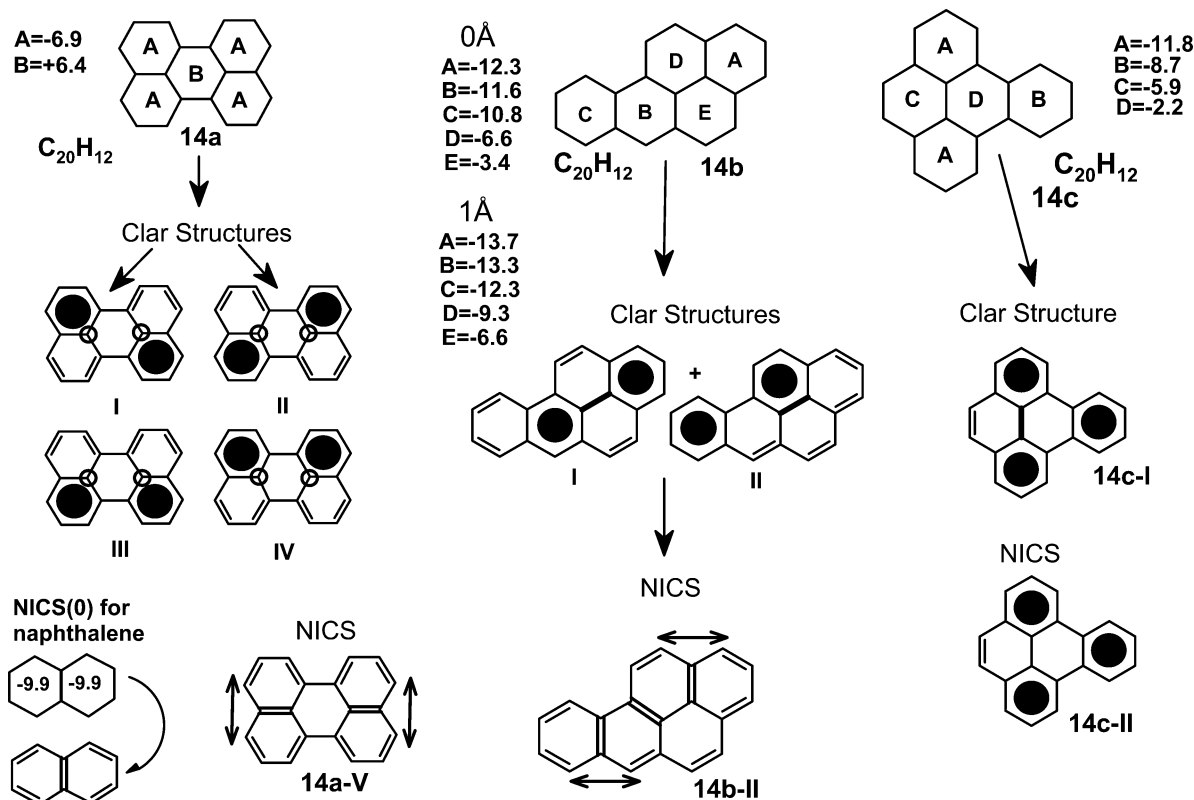

Figure 14. Clar structures obtained with the Clar sextet principle as determined by the Y-rule and calculated NICS(0) values for the most compact PAHs ($P_C = 50\%$) with five fused aromatic rings (5FAR).

density given by the NICS values, **III** (Figure 12), is the pictorial sum or superposition of the two Clar structures, as determined with the Y-rule, named **I** and **II** (Figure 12).

Previously, Suresh and Gadre⁵⁷ showed the existence of the central empty ring in coronene by performing full characterization of the molecular electrostatic potential (MESP) in coronene. The empty ring concept, introduced by Clar,^{8,9} implies that the central ring (B hexagon) π electrons are not in conjugation within that ring.

The NICS values of coronene (**12b**) were previously calculated by Bühl.⁵⁸ The values he reported are NICS = 1.0 for the B hexagon (Figure 12) and NICS = -11.2 for the external hexagons (A hexagons). This would mean that the internal B hexagon in coronene (**12b**) is antiaromatic. However, we found a value of NICS = -1.3, which is aromatic. The basis set used by Bühl is smaller than the one we used. As we discussed in the theoretical methodology, it is necessary to have a large basis set for the calculation of magnetic properties.

On the basis of Bühl's result, Aihara^{51a} has recently pointed out that the NICS calculation of coronene (**12b**) is not a good indicator of its aromaticity. Aihara found, by the calculation of bond resonance energy (BRE), that all of the hexagons in coronene (**12b**) are aromatic and that the central ring is slightly less aromatic than the outer ones.

The experimental reactivity of coronene is helpful to understand its π density. Recently, Foster et al.⁵⁹ studied the growth and photodissociation of $\text{Cr}_x\text{-(coronene)}_y$ complexes. They found that the metal bonding will occur most likely in the external hexagons with three metal atoms in alternant rings, as predicted by the Y-rule. Thus, we consider that both distributions of the π -electronic density for coronene (**12b**), named **I** and **II** (Figure 12), are correct and the sum, or superposition, of these two distributions reproduces the NICS distribution (**III**); see Figure 12.

From the calculated NICS values for **12c** (Figure 12), we conclude that there are four resonant sextets located at the hexagons labeled as A and B, whose NICS value is the highest NICS = -14.4 and -13.9. There are two empty rings that correspond to the D hexagons, NICS = -3.8, and the remaining eight π electrons are located in double bonds at the C hexagons. The final π -electronic density given by the NICS calculation is presented in Figure 12.

12c has 32 π electrons and 10 Y-carbons, which are highlighted in Figure 12. **12c** could have five resonant sextets, but however, as explained above, this highest number of resonant sextets cannot be reached if the percentage of compactness is greater than 79%.⁷ Thus, **12c** can only accommodate four resonant sextets at maximum. The distribution of the resonant sextets that makes use of all of the Y-carbons is given in Figure 12, where the total π density is distributed into four resonant sextets, two empty rings (D hexagons), and four double bonds. This Clar structure agrees with the one obtained by the NICS calculations.

For the case of **12d** (Figure 12 and Table 1), which has 42 π electrons, the Y-rule provides two distributions of the π density or Clar structures, named **12d-I** and **12d-II**, which are related by symmetry. The total number of resonant sextets obtained is five.

The NICS calculation provides the distribution given in **12d-III** (Figure 12) where the E hexagons are empty rings (NICS = -2.3) and there are double bonds right at the junction of the hexagons B and C (NICS = -11.9 and -9.3). The remaining two π electrons should be located at the D hexagons as isolated double bonds in each of them. The calculated NICS values are related by symmetry by applying a rotation through the C_2 axis in the molecule (**12d-III** in Figure 12).

It is important to notice that the π distribution obtained by the NICS calculation, **12d-III**, is also the result of the

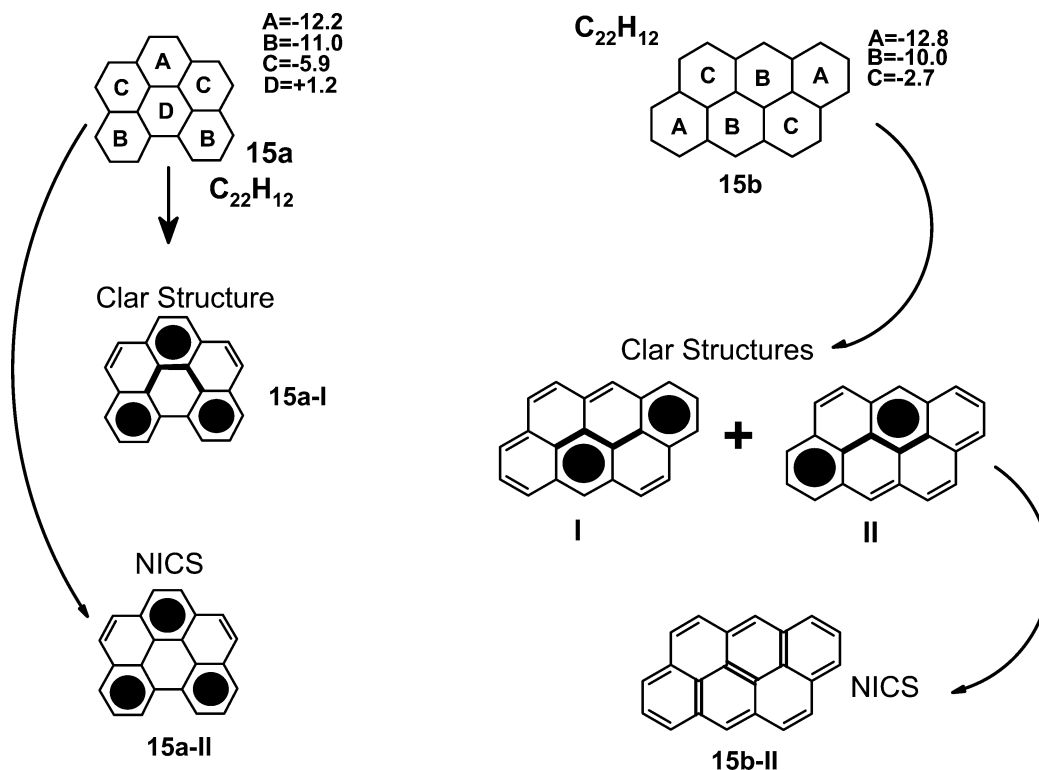

Figure 15. Clar structures obtained with the Clar sextet principle as determined by the Y-rule and calculated NICS(0) values for the most compact PAHs ($P_C = 82\%$) with six fused aromatic rings (6FAR).

superposition of the Clar structures **12d-I** and **12d-II** given by the Y-rule, which reinforces the picture derived from the NICS calculation for a highly symmetric system, as **12d**, in terms of the location of the resonant sextets where the analysis becomes more complex and the computing time increases considerably.

3.5. Clar Structures and NICS for Peri-PAHs with Full Resonant Structure (FRS). In Figure 13, the structure of two PAH systems (**13a** and **13b**) with full resonant structure (FRS) are presented. The FRS systems present only resonant sextets in the structure and no double bonds. The analysis of NICS for PAHs that are not full resonant is difficult due to the ring currents generated in the neighboring hexagons. In the case of FRS compounds, the neighboring hexagons to a hexagon that contains a resonant sextet are empty rings.⁷ Thus, the hexagon that contains the resonant sextet behaves more like an isolated benzene.

In Figure 13, the σ backbone of **13a** is presented together with the calculated NICS values at 0 Å, on the molecular plane, and 1 Å above the molecular plane. Also, the π -electronic distribution obtained by the Clar sextet principle as determined by the Y-rule and from the NICS(0, 1) calculations are presented. **13a** is a FRS that has 8FAR, a stoichiometry $C_{30}H_{16}$, and 30 π electrons to be distributed in the σ backbone. The **13a** system has four Y-carbons (Table 1). The only way to place the resonant sextets and to ensure that all of the Y-carbons are used is presented in **13a-I** (Figure 13). By first placement of the resonant sextets that cover all of the Y-carbons, in the A and B hexagons, it is possible to locate the other two resonant sextets in the C hexagons without overcoming any carbon atom valence. In this way, a total of five resonant sextets are present.

Looking at the calculated NICS(0) (Figure 13), we find that the highest values for **13a** correspond to the A and B hexagons with NICS(0) values of -10.7 and -10.0 ppm, respectively. Thus, the resonant sextets are located in these hexagons. The NICS(0) values for the D and E hexagons are too small

compared with that of benzene (-9.9). Actually, the E hexagon has a NICS(0) value that is positive and close to zero ($+0.2$), and the D hexagon has a NICS(0) = -2.4 ppm, which is smaller than that of benzene (-9.9). We could say that there is no π -electronic density in the hexagons D and E.

The NICS(0) value for the C hexagons is equal to -8.7 ppm, which resembles that of benzene (-9.9) but is smaller than the NICS(0) of the A and B hexagons to consider that there is a resonant sextet in each of the C hexagons. We calculated the NICS(1) where the π contributions are dominant. The calculated NICS(1) for the C hexagons is equal to -10.6 ppm. We could conclude that actually there is a resonant sextet in each of the C hexagons. The total number of resonant sextets found with the NICS calculations is five. The π -electronic distribution obtained from the NICS analysis is presented in **13a-II** (Figure 13). The Clar structure obtained with the Clar sextet principle as determined by the Y-rule and the NICS π -electronic distributions are in agreement (Figure 13).

The **13b** system (Figure 13) contains a total of 10FAR and a percentage of compactness of 49%. This system has 36 π electrons, a stoichiometry of $C_{36}H_{18}$, and a total of six Y-carbons (Table 1 and Figure 13). Because the percentage of compactness is smaller than 79%, then the highest number of resonant sextets, given by the division of the total number of π electrons by 6, can be reached, which is six for this case.⁷

In **13b-I**, the six Y-carbons are highlighted. After applying the Y-rule, we find that there are resonant sextets located in the A, B, and C hexagons. The resonant sextets located in the A and B hexagons ensure that all of the Y-carbons are covered. After placement of the resonant sextets in the A and B hexagons, it is still possible to locate other two sextets in the C hexagons, giving a total of six resonant sextets. In **13b-II**, the distribution obtained from the NICS analysis is presented (Figure 13). The Clar structure and the NICS π -electronic distributions are in agreement.

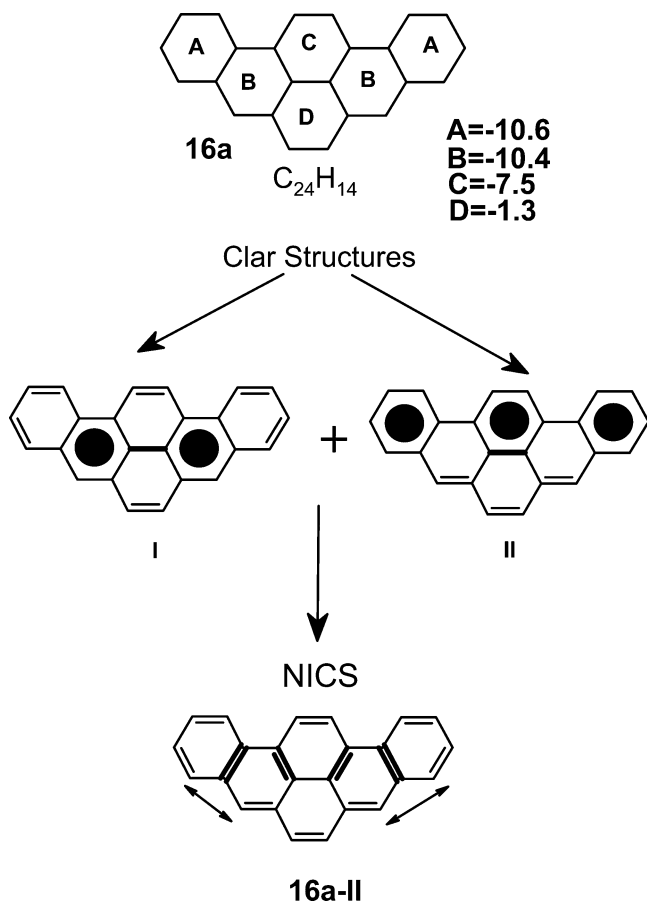

Figure 16. Clar structures obtained with the Clar sextet principle as determined by the Y-rule and calculated NICS(0) values for **16a** ($P_C = 82\%$, 6FAR).

3.6. Clar Structures and NICS for the Peri-PAHs Isomers with Five Fused Aromatic Rings (5FAR). Perylene (**14a**, $C_{20}H_{12}$), Figure 14, has a total of 20 π electrons and two Y-carbons, which are marked in Figure 14 in structures **I** to **IV**. The stoichiometry $C_{20}H_{12}$ can present three or two resonant sextets and one or four double bonds, respectively (Table 1). Given the spatial distribution of the five hexagons that compose perylene (**14a**), it is not possible to have simultaneously three resonant sextets without overcoming the carbon valence. Thus, only two resonant sextets can be accommodated. Actually, the Y-rule helps to find the total number of resonant sextets.

By application of the Y-rule, four possibilities to distribute the π -electronic density are found named **I**, **II**, **III**, and **IV** (Figure 14). Each distribution has two resonant sextets and four double bonds. The central hexagon (B hexagon) is an empty ring. **II** is the mirror image of **I**, and **IV** is the mirror image of **III**.

With the NICS calculation, two types of rings are observed, which are the external A hexagons and the internal B hexagon. The calculated NICS(0) values for the A and B hexagons are -6.9 and $+6.4$ ppm, respectively. The NICS(0) for the A hexagons is the highest in the structure. Thus, the four A hexagons should have the same number of π electrons distributed in the same way. The π -electronic distribution given from the NICS(0) analysis is presented in **14a-V** in Figure 14. As seen in **14a-V**, the four A hexagons present one double bond right at each of the A–A junctions. The double bond right at the junction of two A hexagons does not allow NICS to determine where the resonant sextets are located because there

is a resonant sextet in each A hexagon–A hexagon unit that migrates along the A hexagons.

The calculated NICS(0) for the B hexagon is $+6.4$ ppm. This value is positive and very different from the NICS(0) value for the A hexagons. We could say that there is no π density in this hexagon because all of the π density has already been distributed in the A hexagons. The B hexagon is actually an empty ring.

Perylene (**14a**) has two naphthalene fragments. It is reported in the literature that in perylene (**14a**) the π density is located in the naphthalene fragments and distributed in the same way as in naphthalene.⁵⁰ The calculated NICS(0) for naphthalene has been reported by Schleyer.³² It is reported as NICS(0) = -9.9 ppm for both hexagons (Figure 14). Thus, the NICS(0) calculation for naphthalene shows that there is only one resonant sextet that migrates along the two hexagons that compose naphthalene. This same phenomenon is observed in the naphthalene fragments of perylene (**14a**).

Again as seen in Figure 14, the pictorial sum or superposition of the four Clar structures, given by the Y-rule, **I** to **IV**, reproduces **14a-V**. In this way, this rule helps to understand how the π density is distributed when there is sextet migration in the structure.

14b (Figure 14) also has a total of 20 π electrons to be accommodated in sextets and double bonds. This structure also has a total of two Y-carbons, which are highlighted. There are two π -electronic distributions obtained by the Clar sextet principle as determined by the Y-rule, **I** and **II**. In the π -electronic distribution **I**, there are resonant sextets in the A and B hexagons, and the remaining π density is located in the C, D, and E hexagons. In the π -electronic distribution **II**, there are resonant sextets in the D and C hexagons, and the remaining π density is located in the A, B, and E hexagons, Figure 14.

The calculated NICS(0) values for **14b** are presented in Figure 14. The highest NICS(0) value corresponds to hexagons A, B, and C whereas the calculated highest NICS(1) correspond to the hexagons A, B, C, and D, Figure 14. Thus, we could say that the resonant sextets are located in hexagons A and B, but the resonant sextet in the B hexagon migrates between the C and B hexagons, and the resonant sextet in the A hexagon migrates between the A and D hexagons, as shown in **14b-II**. Also, there is a double bond right at the junction of the B–D hexagons. The π distribution obtained from the NICS analysis is presented in **14b-II** (Figure 14), and it is equal to the superposition of the two Clar structures **I** and **II**.

14c is the last $C_{20}H_{12}$ isomer. The π distributions obtained with the Clar sextet principle as determined by the Y-rule and the NICS results are presented in Figure 14 as **14c-I** and **14c-II**. The calculated NICS(0) values are given in **14c** (Figure 14). Both π -electronic distributions agree.

3.7. Clar Structures and NICS for the Peri-PAHs Isomers with Six Fused Aromatic Rings (6FAR). There are only two $C_{22}H_{12}$ isomers (**15a** and **15b**), which are presented in Figure 15. These isomers present six FAR, four Y-carbons (Table 1), which are highlighted, and a total of 22 π electrons.

The π -electronic distribution obtained by the Clar sextet principle as determined by the Y-rule and the NICS(0) calculation for **15a** are presented in Figure 14 as **15a-I** and **15a-II**, respectively. The calculated NICS(0) values are given in **15a** (Figure 14). Again, both π -electronic distributions agree.

15b (Figure 15) presents two π -electronic distributions obtained from the Clar sextet principle as determined by the Y-rule. These distributions are depicted in **I** and **II**. Both distributions have a total of two resonant sextets and five double bonds.

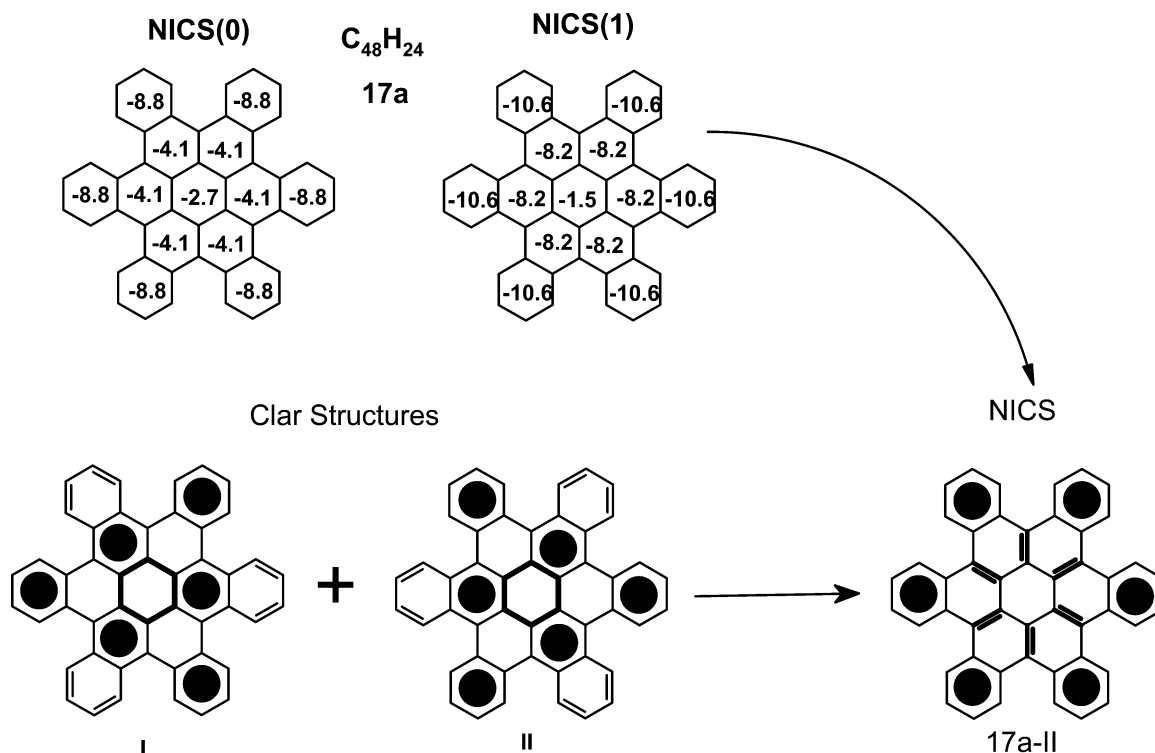

Figure 17. Clar structures obtained with the Clar sextet principle as determined by the Y-rule and calculated NICS(0) and NICS(1) values for **17a**.

The calculated NICS(0) values for **15b** are given in Figure 14. The highest values correspond to the A and B hexagons. Thus, we consider that there are double bonds right at the junctions of the A–B hexagons, the B–B hexagons, and the B–A hexagons as depicted in **15b-II** (Figure 15). Due to this situation, it is not possible to locate the resonant sextets in a particular hexagon.

It is important to notice that the pictorial sum of **I** and **II**, which are the π distributions obtained with the Clar sextet principle as determined by the Y-rule, reproduce the π distribution obtained by the NICS analysis, **15b-II** (Figure 15).

The **16a** system (Figure 16) has 24 π electrons and two Y-carbons. By application of the Y-rule, two π -electronic distributions are found, which are presented in Figure 16 as **I** and **II**. Both distributions ensure that all of the Y-carbons are covered by a sextet. However, the distribution **II** provides a higher number of resonant sextets.

The Y-rule states that the distribution that provides the highest number of resonant sextets is the most likely to prevail because it is more stable. Each resonant sextet confers a stability of 36 kcal/mol.^{11–16} Thus, the distribution **II** presented in Figure 16 is the most probable one.

The highest NICS(0) values are calculated for the A and B hexagons (Figure 16). Their NICS(0) values, -10.6 and -10.4 , respectively, are close. Because there cannot be simultaneously a resonant sextet in each hexagon, this means that there is one resonant sextet migrating between the A and B hexagons. However, because there are two “A hexagon fused to B hexagon” units in the structure, there are two resonant sextets migrating.

The NICS(0) calculated for the C hexagon is equal to -7.5 , which is smaller than the NICS(0) of the A and B hexagons. We consider that there could be a double bond right at the junction of the B and C hexagons and that the effect of the paratropic current, felt at the C hexagon and generated as a diatropic current in the neighboring B hexagons, decreases the diamagnetic current created in the C hexagon, by the application

of the magnetic external field. The final π -electronic distribution obtained from the NICS analysis is given in **16a-II** (Figure 16).

The D hexagon NICS(0) is -1.3 . This value is much smaller than the NICS(0) of the other hexagons presented in the structure. In this hexagon, the remaining electronic π density (two electrons) must be distributed as a double bond; see **16a-II**. Again, the pictorial sum of **I** and **II** produces as a result the π distribution obtained from the NICS analysis (Figure 16).

3.8. Clar Structures and NICS for a Peri-PAH System with 13 Fused Aromatic Rings (13FAR). The system **17a** (Figure 17) with 48 π electrons has six Y-carbons, which are highlighted. After application of the Y-rule, two π -electronic distributions are obtained named **I** and **II** (Figure 17). Both distributions present four empty rings in the internal hexagons, which resemble triphenylene, and both distributions contain six resonant sextets and six double bonds.

The calculated NICS(0) and NICS(1) are also given in Figure 17. Three types of hexagons are obtained, the external hexagons, which present the highest NICS value, the internal hexagons, and the central hexagon. The NICS analysis for this compound has been performed previously by Moran et al.¹⁸

There are resonant sextets in all of the external hexagons, which present the highest NICS value. The calculated NICS is equal for all of the internal hexagons, meaning that their electronic environment is the same for all of them. This is only possible if they share a double bond right at the junctions. The central hexagon is an empty ring with a very small NICS value NICS(1) = -1.5 ppm (Figure 17).

The π -electronic distribution obtained from the NICS calculation is given as **17a-II** in Figure 17. Again, the pictorial sum or superposition of the π -electronic distributions obtained by the Clar sextet principle as determined by the Y-rule (**I** and **II**, Figure 17) reproduces the π -electronic distribution obtained from the NICS analysis.

Randic²⁰ presents in his paper, “On Construction of Clar Structures for Large Benzenoids”, the 18 Clar structures for hexabenzocoronene (**17a**), which have the largest number of

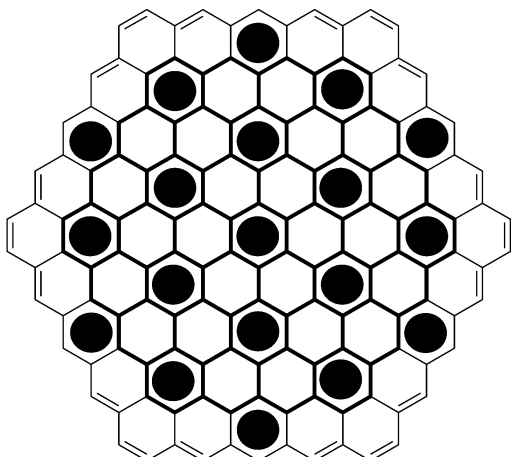
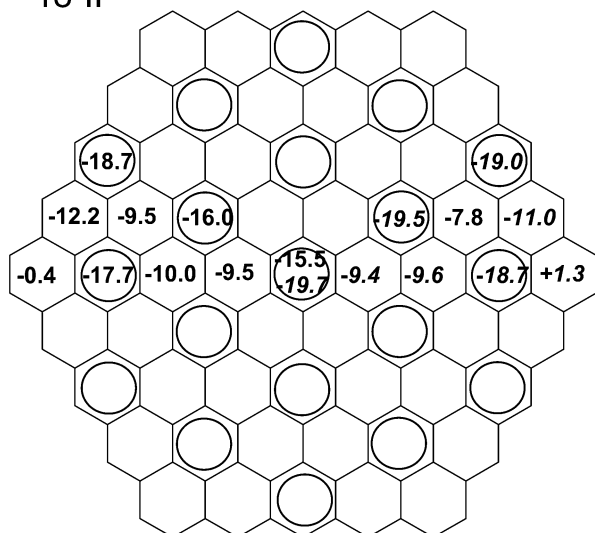
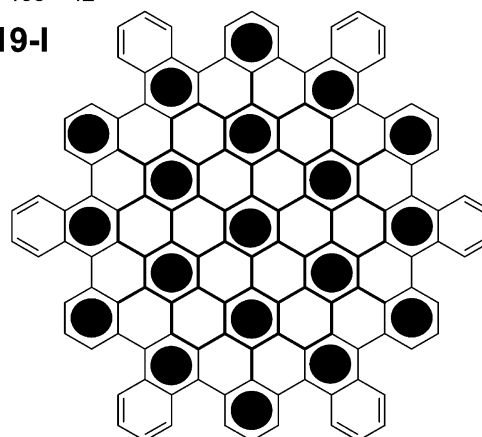
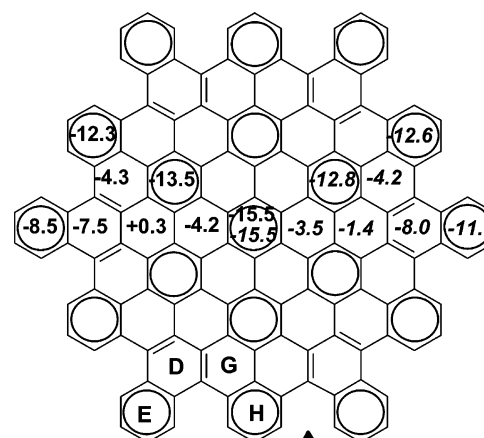
Clar Structure $C_{150}H_{30}$
18-INICS
18-II $C_{138}H_{42}$ Clar Structure
19-INICS
19-II

Cove region

19-III

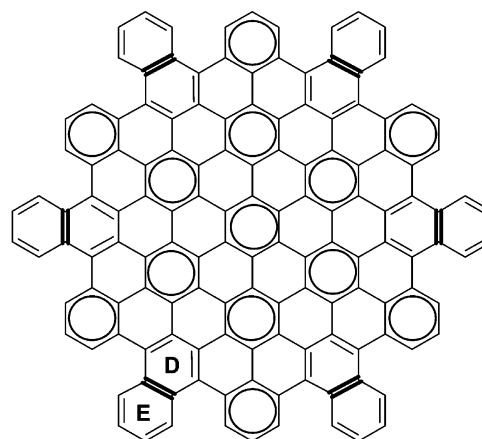

Figure 18. Clar structure obtained with the Clar sextet principle as determined by the Y-rule and calculated NICS for a large PAH ($C_{150}H_{30}$). The solid circles and the open circles represent aromatic resonant sextets in both cases.

resonant sextets, which is six. Not all of the Clar structures are related by symmetry. Clar discussed the NMR spectra of **17a** in terms of the two Clar structures found by the Y-rule instead of the 18 structures found by Randic. The superposition of the two structures proposed by Clar and also found with the Y-rule (**I** and **II** in Figure 17) gives the structure **17a-II**, which is the most important Clar structure because it is responsible for the aromaticity in hexabenzocoronene (**17a**) as it is also supported by the NICS calculation.

3.9. The π -Electronic Distribution in Large Peri-PAHs.

After the discussion presented in the former sections, we can say that there is an agreement between the π -electronic distributions obtained by the Clar sextet principle (or model) as determined by the Y-rule and the NICS calculations. However, the science of PAHs has advanced to the synthesis of large PAHs,³⁶ and these extended π systems create challenging problems for any discussions about π structure. In this section, we test the performance of the Y-rule for large PAHs by comparing the Clar structures obtained with it and the NICS calculations. In this section, all of the NICS results were taken

Figure 19. Clar structures obtained with the Clar sextet principle as determined by the Y-rule and calculated NICS for a large PAH ($C_{138}H_{42}$). The solid circles and the open circles represent aromatic resonant sextets in both cases.

from the literature and the corresponding reference is presented in each case. In the former sections, we carried out the NICS calculations because the values were not reported in the literature for most of the structures presented.

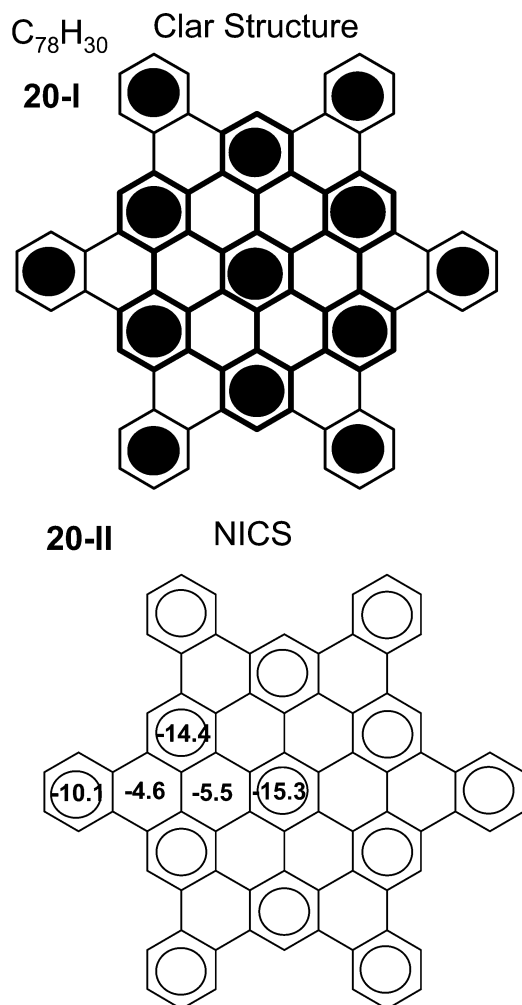

Figure 20. Clar structures obtained with the Clar sextet principle as determined by the Y-rule and calculated NICS for a large PAH ($C_{78}H_{30}$). The solid circles and the open circles represent aromatic resonant sextets in both cases.

There are not many papers in the literature where the π -electron distribution in large PAHs is calculated with the NICS approach or any other aromaticity approach due to the size of the systems and their complexity. In a recent paper, Moran et al.¹⁸ use NICS calculations to discuss the π -electron distribution in eight very large PAHs (ranging from 19 to 91 fused aromatic rings or hexagons) and conclude that the NICS and the Clar valence electron topologies (sextet/double bond description) agree perfectly in the molecular plane.

From Figure 18 to Figure 23, we present π -electronic distributions obtained by the Clar sextet principle (or model) as determined by the Y-rule for several large PAHs. In all of the figures, the solid circles and the open circles represent aromatic resonant sextets in both cases.

In Figure 18, a large PAH ($C_{150}H_{30}$) with a compact structure is presented. This compound presents 61 fused aromatic rings (61FAR). In **18-I**, the π -electronic distribution obtained by the Clar sextet principle (or model) as determined by the Y-rule is presented. In **18-II**, the NICS(1) values reported in the literature are presented. The numbers in italics were recently calculated by Hajgató and Ohno,³⁷ and the other numbers were calculated by Moran et al.¹⁸ As seen in **18-II** (the double bonds are not drawn for clarity), the NICS values calculated by different authors vary; however, the highest values, in both cases,

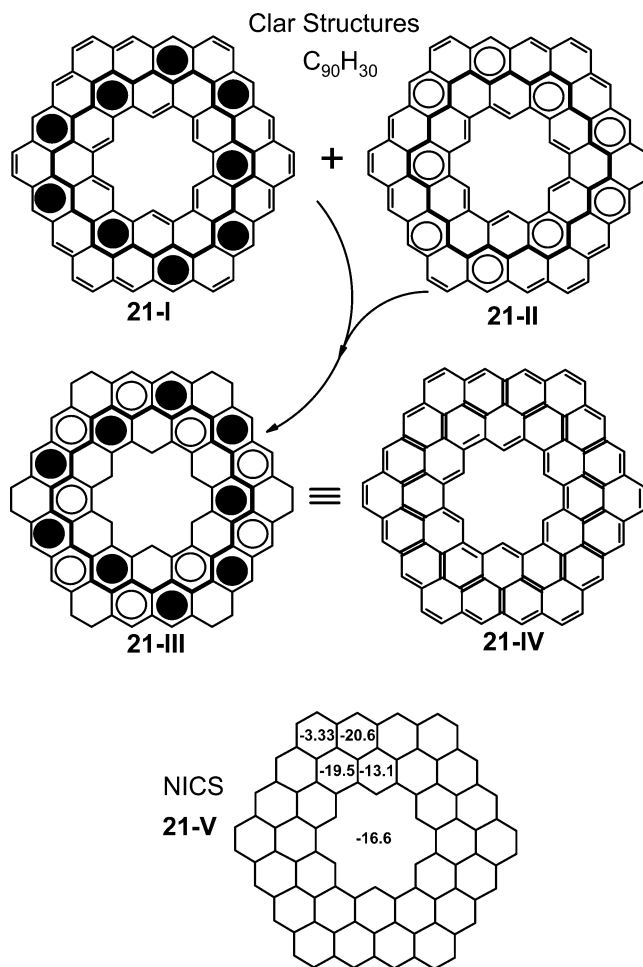

Figure 21. Clar structures obtained with the Clar sextet principle as determined by the Y-rule and calculated NICS for a large PAH which is constructed from condensed hexagon rings but that presents a hollow site ($C_{90}H_{30}$). The solid circles and the open circles represent aromatic resonant sextets in both cases.

represent the location of the resonant sextets. As seen in Figure 18, the Clar structures agree with the one obtained from the NICS calculations.

In Figure 19, the compound $C_{138}H_{42}$ is presented. This compound has 49 fused aromatic rings (49FAR) and 138 π electrons to be distributed in Clar sextets and double bonds. The π -electronic distribution obtained by the Clar sextet principle as determined by the Y-rule is presented in **19-I**. There are 19 resonant sextets and 12 double bonds distributed in six “terminal” hexagons. Each “terminal” hexagon has two exocyclic double bonds.

The NICS(1) for this system has recently been calculated by Moran et al.¹⁸ In Figure **19-II**, the calculated NICS(1)¹⁸ are given. These authors performed two types of calculations for this system. The numbers in italics are the NICS(1) obtained for a D_{6h} symmetry, whereas the other numbers were obtained for a D_{3d} symmetry, and in both cases the highest values represent the location of resonant sextets. The NICS(1) obtained for both symmetries agree in general, except for the case of the E hexagons (“terminal” hexagons) and the D hexagons (**19-II**).

For the D_{6h} symmetry, the NICS value of the E hexagon is very high (-11.6 , in italics) and comparable to the highest values, and because of this it could be concluded that in each of these E hexagons there is a resonant sextet as shown in **19-II**. However, this picture changes when the D_{3d} symmetry is considered. In the D_{3d} case, the NICS values of the E hexagons

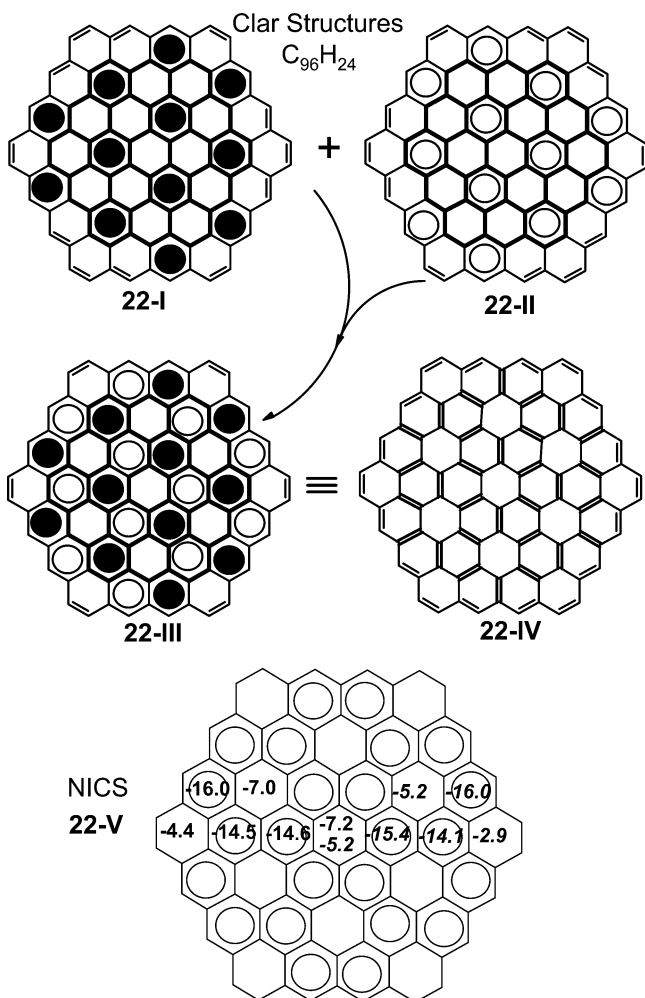

Figure 22. Clar structures obtained with the Clar sextet principle as determined by the Y-rule and calculated NICS for a large PAH ($C_{96}H_{24}$). The solid circles and the open circles represent aromatic resonant sextets in both cases.

are close to those of the D hexagons, -8.5 and -7.5 , respectively, whereas the highest values, for this symmetry, are around -12 to -15 ppm. Then we cannot say for certain if there is a resonant sextet in the E hexagons.

Moran et al.¹⁸ opted for the D_{6h} NICS(1) analysis, giving the π distribution presented in **19-II**. However, this molecule cannot be planar (D_{6h}) due to the existence of steric hindrance between the hydrogen atoms in the cove areas formed by the E–D–G–H hexagons (**19-II**), Figure 19.

Thus, we consider that the NICS values of the D_{3d} symmetry are most likely to represent the actual π -electron distribution and that there is a double bond right at the junction of the E and D hexagons, as presented in **19-III**. This representation (**19-III**) is in closer agreement to the Clar structure given by the Y-rule.

In Figure 20, the compound $C_{78}H_{30}$ is presented. This compound has 25 fused aromatic rings (25FAR) and 78 π electrons to be distributed in Clar sextets. This compound represents a full-resonant benzenoid PAH. The π -electronic distribution obtained by the Clar sextet principle (or model) as determined by the Y-rule is presented in **20-I**, which is in agreement with the NICS calculation performed by Moran et al.¹⁸ (**20-II**).

In Figure 21, we present a large PAH that is constructed from condensed hexagon rings but presents a hollow site. This system

has the molecular formula $C_{90}H_{30}$ and 30FAR. Recently, Hajgató and Ohno³⁷ have calculated the NICS(1) of a series of this compound with one or more hollow sites. By use of the Y-rule two Clar-type distributions of the π -electronic density are obtained, **21-I** and **22-II** (Figure 21). The superposition of both distributions, shown as **21-III** (only the resonant sextets are shown, Figure 21), is equivalent to the distribution **21-IV**.

In **21-III**, there is sextet migration between sextets, represented as black solid circles, and sextets, represented as open circles. As seen in **21-IV**, there are double bonds right at the junction of the hexagons that are arranged in a zigzag fashion and that involve the Y-carbons. The NICS values calculated by Hajgató and Ohno³⁷ are presented in **21-V**, and they are in agreement with the π -electronic distribution obtained by the Clar sextet principle as determined by the Y-rule (**21-IV**).

In Figure 22, the compound $C_{96}H_{24}$ is presented. This compound has 37 fused aromatic rings (37FAR) and 96 π electrons to be distributed in Clar sextets and double bonds. Two Clar-type π -electronic distributions are obtained with the Y-rule, named **22-I** and **22-II**. There are 12 resonant sextets and 12 double bonds distributed in **22-I** and **22-II**. The superposition of both distributions is shown as **22-III** (Figure 22), and it is equivalent to the distribution **22-IV**.

In **22-III**, there is sextet migration between sextets represented as black solid circles and sextets represented as open circles. As seen in **22-IV**, there are double bonds right at the junction of the hexagons that are involved in sextet migration.

In **22-V**, the NICS(1) values reported in the literature are presented. The numbers in italics were recently calculated by Hajgató and Ohno,³⁷ and the other numbers were calculated by Moran et al.¹⁸ As seen in **22-V** (the double bonds are not drawn for clarity), the NICS values calculated by different authors vary. However, the highest values in both cases represent the location of the resonant sextets. As seen in Figure 22, the π -electronic distributions obtained by the Clar sextet principle as determined by the Y-rule (**22-III** or **22-IV**) agree with that obtained from the NICS calculations.

In Figure 23, the compound $C_{276}H_{60}$ is presented. This compound has 109 fused aromatic rings (109FAR) and 276 π electrons to be distributed in Clar sextets and double bonds. Only two Clar-type π -electronic distributions are obtained with the Y-rule, named **23-I** and **23-II**, Figure 23. There are 36 resonant sextets and 30 double bonds distributed in **23-I** and **23-II**. The double bonds are located mostly in the external terminal hexagons.

The superposition of both distributions (**23-I** and **23-II**) is shown as **23-III** (Figure 23), where there is sextet migration between sextets represented as black solid circles and sextets represented as open circles. As seen in **23-IV**, which is the Kekulé equivalent representation of **23-III**, there are double bonds right at the junction of the hexagons that are involved in sextet migration and that also involve the Y-carbons.

The biggest PAH system that we present in this paper is the $C_{276}H_{60}$ with 109 fused hexagons, for which there are no NICS results reported in the literature. It took us 30 min to establish the π -electronic distribution obtained by the Clar sextet principle as determined by the Y-rule (**23-III** or the Kekulé distribution **23-IV**). However, after 3 weeks of supercomputing for the NICS calculation our job has not finished yet. Thus, for this particular case we present the Y-rule prediction of the relative values we expect from the NICS calculation.

In **23-IV**, we have labeled with letters all of the different hexagons present in the structure. We predict that the NICS calculation will generate the Clar structure **23-III**. This means

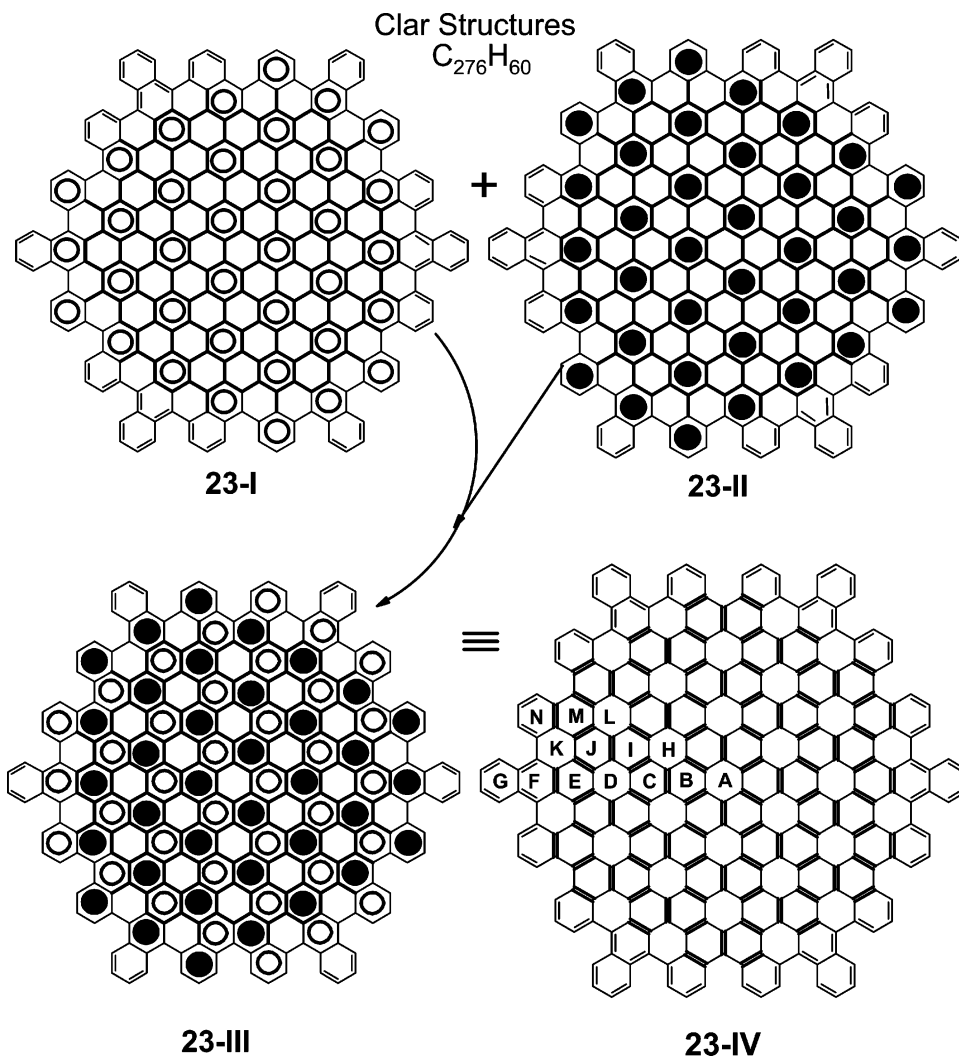

Figure 23. Clar structures obtained with the Clar sextet principle as determined by the Y-rule for a large PAH ($C_{276}H_{60}$). The solid circles and the open circles represent aromatic resonant sextets in both cases. The bold lines in **23-IV** represent double bonds right at the junction of the hexagons involved in sextet migration.

that the NICS values would have the following order: $B \approx C \approx I \approx J > E \approx M \approx N \gg F > G > A \approx D \approx H \approx K \approx L$.

We predict that the symmetry related hexagons labeled as A, D, H, K, and L actually are empty rings. Thus, we expect that their NICS values will be close to zero or positive. However, we predict that the NICS values of the hexagons labeled as B, C, I, and J present the highest NICS values. The hexagons labeled as E, M, and N are predicted to have large values too but smaller than those of the B, C, I, and J hexagons because they are closer to the external hexagons, F and G.

For this particular system, $C_{276}H_{60}$, Randić et al.²⁰ predicted a count of Clar structures, with the highest number of resonant sextets (36), on the order of 10^5 . They consider that finding and characterizing all Clar valence structures in large benzenoids is an important step for a quantitative description of molecular properties, such as spectra and bond length. They concluded, given the large number of Clar structures predicted by them, that there are computational limitations associated with Clar's model when extended to large systems with delocalized π sextets.

We have proven in this section that it is not necessary to find all of the Clar valence structures in large benzenoids to understand their aromaticity, but it is only important to consider the π -electronic distribution(s) obtained by the Clar sextet

principle as determined by the Y-rule, which represent the most important Clar structures, and their superposition, in the case of the existence of sextet migration.

4. Conclusions

In the present work, we verify theoretically the performance of the Y-rule that extends the sextet–double bond description of Clar's model for peri-PAHs by predicting, in an easy way, the most likely location and total number of aromatic sextets. Accordingly, the π -electronic distribution obtained by the Clar sextet principle (or model) as determined by the Y-rule is compared with the π -electronic distribution obtained from nucleus-independent chemical shift (NICS) calculations for various series of benzenoid peri-PAHs. It is found that there is an agreement between the Clar structures and NICS values in peri-PAHs of any size.

The advantages of the qualitative Y-rule are that it is of particular importance for the case of large peri-PAHs, it takes few minutes to be applied following a very easy methodology, and it provides a quick answer about the aromaticity and location of the resonant sextets in peri-PAH compounds without having to carry out theoretical quantum chemistry calculations that take time and that can be costly depending on the size of the system.

We suggest that the use of drawing circles in each hexagon of the σ frame in peri-PAHs to represent the distribution of the π density must be discouraged. This practice has been done since long ago^{10–16} because of the fact that it was not possible to know, in an easy way, where the resonant sextets and the double bonds are located. We suggest that this problem can be overcome by establishing the Clar structures obtained with the Clar sextet principle as determined by the Y-rule.

Despite the fact that the NICS values represent strong theoretical support for Clar's picture of aromatic π -sextets,^{10,18,32,34,35,40,41} it takes computational time and complex analysis in some cases. The larger the peri-PAH system, the longer the computational time required. Only the full-resonant structures or total-resonant structures (for example those presented in Figure 13) show the extreme NICS values, whereas the peri-PAH compounds that are not full resonant and that have migrating sextets show, for several hexagonal rings, intermediate NICS values.^{10,18} In these cases, we found that the highest NICS value obtained in the entire structure should be taken as reference to locate the sextets instead of comparison with the NICS of benzene.

For the particular large PAH, C₂₇₆H₆₀, Randić et al.²⁰ predicted a count of Clar structures, with the highest number of resonant sextets (36), on the order of 10⁵. They consider that finding and characterizing all of the Clar valence structures in large benzenoids is an important step for a quantitative description of molecular properties, such as spectra and bond length. They concluded, given the large number of Clar structures predicted by them, that there are computational limitations associated with Clar's model when extended to large systems with delocalized π sextets.

We have proven in this paper and in particular for the case of large PAHs, where the NICS calculation is highly costly and time-consuming, that the best option to elucidate the aromaticity is to consider the π -electronic distribution obtained by the Clar sextet principle (or model) as determined by the Y-rule. This π -electronic distribution represents the most important Clar structures, and their superposition, in the case of sextet migration existence. Thus, it is not necessary to find all of the Clar valence structures to understand the aromaticity.

Acknowledgment. We gratefully acknowledge Dr. Oliver C. Mullins and Dr. Marcelo Lozada-Cassou for fruitful and motivating discussions. Thanks are due to Dr. Fernando Alvarez-Ramirez for his assistance with the preparation of inputs for NICS calculations and to Ms. Mireya Villanueva for her assistance with system administration. This work is dedicated to the memory of Dr. Maria-Teresa Ruiz-Morales, M.D.

References and Notes

- (1) (a) Zajac, G. W.; Sethi, N. K.; Joseph, J. T. *Scanning Microsc.* **1994**, *8*, 463. (b) *Bitumens, Asphalts, and Tar Sands*; Chilingarian, G. V., Yen, T. F., Eds.; Elsevier: New York, 1978.
- (2) Speight, J. G. *The Chemistry and Technology of Petroleum*; Marcel Dekker: New York, 1980; pp 189–252.
- (3) Tissot, B. P.; Welte, D. H. *Petroleum Formation and Occurrence*, 2nd ed.; Springer-Verlag: Berlin, 1984.
- (4) *Chemistry of Asphaltenes*; Bunger, J. W., Li, N. C., Eds.; American Chemical Society: Washington, DC, 1984.
- (5) *Asphaltenes: Fundamentals and Applications*; Sheu, E. Y., Mullins, O. C., Eds.; Plenum Press: New York, 1995.
- (6) *Structures and Dynamics of Asphaltenes*; Mullins, O. C., Sheu, E. Y., Eds.; Plenum Press: New York, 1998.
- (7) Ruiz-Morales, Y. *J. Phys. Chem. A* **2002**, *106*, 11283.
- (8) Clar, E. *Polycyclic Hydrocarbons*; Academic: London, 1964.
- (9) Clar, E. *The Aromatic Sextet*; Wiley: London, 1972.
- (10) Randić, M. *Chem. Rev.* **2003**, *103*, 3449.
- (11) (a) Havenith, R. W. A.; van Lenthe, J. H.; Dijkstra, F.; Jenneskens, L. W. *J. Phys. Chem. A* **2001**, *105*, 3838. (b) Havenith, R. W. A.; Jiao, H.; Jenneskens, L. W.; van Lenthe, J. H.; Sarobe, M.; Schleyer, P. v. R.; Kataoka, M.; Nuclea, A.; Scott, L. T. *J. Am. Chem. Soc.* **2002**, *124*, 2363.
- (12) Krygowki, T. M.; Cyranski, M. K. *Chem. Rev.* **2001**, *101*, 1385.
- (13) Gomes, J. A. N. F.; Mallion, R. B. *Chem. Rev.* **2001**, *101*, 1349.
- (14) De Proft, F.; Geerlings, P. *Chem. Rev.* **2001**, *101*, 1451.
- (15) Mitchell, R. H. *Chem. Rev.* **2001**, *101*, 1301.
- (16) Garrat, P. J. *Aromaticity*; John Wiley and Sons: New York, 1986; Chapter 9.
- (17) Havenith, R. W. A.; van Lenthe, J. H.; Dijkstra, F.; Jenneskens, L. W. *J. Phys. Chem. A* **2001**, *105*, 3838.
- (18) Moran, D.; Stahl, F.; Bettinger, H. F.; Schaefer, H. F.; Schleyer, P. v. R. *J. Am. Chem. Soc.* **2003**, *125*, 6746.
- (19) Fries, K. *Justus Liebigs Ann. Chem.* **1927**, *454*, 121.
- (20) Randić, M.; Hosoya, H.; Nakada, K. *Polycyclic Aromat. Compd.* **1995**, *4*, 249.
- (21) Hosoya, H.; Yamaguchi, T. *Tetrahedron Lett.* **1975**, 4659.
- (22) Herndon, W. C.; Hosoya, H. *Tetrahedron* **1984**, *40*, 3987.
- (23) Randić, M. Clar's π -Aromatic Sextet Revisited. In *Valence Bond Theory*; Cooper, D. L., Ed.; Elsevier: Amsterdam, 2002; Chapter 16, pp 503–533.
- (24) Hosoya, H.; Hosi, K.; Gutman, I. *Theor. Chim. Acta* **1975**, *38*, 37.
- (25) (a) Aihara, J. *J. Org. Chem.* **1976**, *41*, 2488. (b) Aihara, J. *J. Chem. Soc., Perkin Trans.* **1996**, *2*, 2185. (c) Aihara, J. *J. Phys. Chem. A* **1999**, *103*, 7487. (d) Aihara, J. *J. Org. Chem.* **1976**, *41*, 2488. (e) Aihara, J. *J. Am. Chem. Soc.* **1977**, *99*, 2048.
- (26) Herndon, W. C. *J. Am. Chem. Soc.* **1973**, *95*, 2404.
- (27) Herndon, W. C.; Ellzey, M. L. *J. Am. Chem. Soc.* **1974**, *96*, 6631.
- (28) Randić, M. *Tetrahedron* **1975**, *31*, 1477.
- (29) Randić, M. *Chem. Phys. Lett.* **1976**, *38*, 68.
- (30) Randić, M. *J. Am. Chem. Soc.* **1977**, *99*, 444.
- (31) Randić, M. *Tetrahedron* **1977**, *33*, 68.
- (32) Schleyer, P. v. R.; Maerker, C.; Dransfeld, A.; Jiao, H.; Hommes N. J. R. v. E. *J. Am. Chem. Soc.* **1996**, *118*, 6317.
- (33) Fleischer, U.; Kutzelnigg, W.; Lazzaretti, P.; Mühlenkamp, V. J. *Am. Chem. Soc.* **1994**, *116*, 5298.
- (34) Schleyer, P. v. R. *Chem. Rev.* **2001**, *101*, 1115.
- (35) Patchkovskii, S.; Thiel, W. *J. Mol. Model.* **2000**, *6*, 67 and references therein.
- (36) Watson, M. D.; Fechtenkötter, A.; Müllen, K. *Chem. Rev.* **2001**, *101*, 1267.
- (37) Hajgató, B.; Ohno, K. *Chem. Phys. Lett.* **2004**, *385*, 512.
- (38) Samori, P.; Severin, N.; Simpson, C. D.; Müllen, K.; Rabe, J. J. *Am. Chem. Soc.* **2002**, *124*, 9454.
- (39) Bergmann, U.; Groenzin, H.; Mullins, O. C.; Glatzel, P.; Fetzer, J.; Cramer S. P. *Chem. Phys. Lett.* **2003**, *369*, 184.
- (40) Schleyer, P. v. R.; Jiao, H.; Hommes, N. J. R. v. E.; Malkin, V. G.; Malkina, O. L. *J. Am. Chem. Soc.* **1997**, *119*, 12669.
- (41) Schleyer, P. v. R.; Manoharan, M.; Wang, Z.-X.; Kiran, B.; Jiao, H.; Puchta, R.; Hommes, N. J. R. v. E. *Org. Lett.* **2001**, *3*, 2465.
- (42) Molecular Simulation Incorporated. *Cerius2 Modeling Environment*, release 4.0; Molecular Simulations Incorporated: San Diego, CA, 1999.
- (43) (a) Ditchfield, R. *Mol. Phys.* **1974**, *27*, 789. (b) Wolinski, K.; Hinton, J. F.; Pulay, P. *J. Am. Chem. Soc.* **1990**, *112*, 8251.
- (44) Frisch, M. J.; Trucks, G. W.; Schlegel, H. B.; Scuseria, G. E.; Robb, M. A.; Cheeseman, J. R.; Zakrzewski, V. G.; Montgomery, J. A., Jr.; Stratmann, R. E.; Burant, J. C.; Dapprich, S.; Millam, J. M.; Daniels, A. D.; Kudin, K. N.; Strain, M. C.; Farkas, O.; Tomasi, J.; Barone, V.; Cossi, M.; Cammi, R.; Mennucci, B.; Pomelli, C.; Adamo, C.; Clifford, S.; Ochterski, J.; Petersson, G. A.; Ayala, P. Y.; Cui, Q.; Morokuma, K.; Malick, D. K.; Rabuck, A. D.; Raghavachari, K.; Foresman, J. B.; Cioslowski, J.; Ortiz, J. V.; Stefanov, B. B.; Liu, G.; Liashenko, A.; Piskorz, P.; Komaromi, I.; Gomperts, R.; Martin, R. L.; Fox, D. J.; Keith, T.; Al-Laham, M. A.; Peng, C. Y.; Nanayakkara, A.; Gonzalez, C.; Challacombe, M.; Gill, P. M. W.; Johnson, B. G.; Chen, W.; Wong, M. W.; Andres, J. L.; Head-Gordon, M.; Replogle, E. S.; Pople, J. A. *Gaussian 98*, revision A.7; Gaussian, Inc.: Pittsburgh, PA, 1998.
- (45) Becke, A., *Phys. Rev. A: At., Mol., Opt. Phys.* **1988**, *38*, 3098.
- (46) Lee, C.; Yang, W.; Parr, R. G., *Phys. Rev. B: Condens. Matter Mater. Phys.* **1988**, *37*, 785.
- (47) Chesnut, D. B. In *Annual Reports on NMR Spectroscopy*; Webb, G. A., Ed.; Academic Press: New York, 1994; Vol. 29.
- (48) Kutzelnigg, W.; Fleischer, U.; Schindler, M. In *NMR, Basic Principles and Progress*; Springer-Verlag: Berlin, 1990; Vol. 23, p 165.
- (49) (a) Dias, J. R. *Polycyclic Aromat. Compd.* **1994**, *4*, 87. (b) Dias, J. R. *HEOCHEM* **1991**, *230*, 155. (c) Dias, J. R. *Polycyclic Aromat. Compd.* **1994**, *4*, 87. (d) Dias, J. R. *THEOCHEM* **1993**, *284*, 11. (e) Dias, J. R. *THEOCHEM* **1991**, *230*, 155. (f) Dias, J. R. *Theor. Chim. Acta* **1990**, *77*, 143. (g) Dias, J. R. *Polycyclic Aromat. Compd.* **1999**, *14–15*, 63. (h) Dias, J. R. *Acc. Chem. Res.* **1985**, *18*, 241.

(50) Iuliucci, R. J.; Phung, C. G.; Facelli, J. C.; Grant, D. M. *J. Am. Chem. Soc.* **1996**, *118*, 4880.

(51) (a) Aihara, J. *Chem. Phys. Lett.* **2002**, *365*, 34. (b) Aihara, J.; Horikawa, T. *Bull. Chem. Soc. Jpn.* **1983**, *56*, 1853. (c) Aihara, J. *J. Am. Chem. Soc.* **1985**, *107*, 298. (d) Aihara, J. *Bull. Chem. Soc. Jpn.* **1985**, *58*, 1045.

(52) Steiner, E.; Fowler, P. W. *Int. J. Quantum Chem.* **1996**, *60*, 609.

(53) Steiner, E.; Fowler, P. W.; Jenneskens, L. W. *Angew. Chem., Int. Ed.* **2001**, *40*, 362.

(54) Lazzeretti, P. *Prog. Nucl. Magn. Reson. Spectrosc.* **2000**, *36*, 1.

(55) Gutman, I.; Brunvoll, J.; Cyvin, B. N.; Brendsdal, E.; Cyvin, S. J. *Chem. Phys. Lett.* **1994**, *219*, 355.

(56) Ligabue, A.; Pincelli, U.; Lazzeretti, P.; Zanasi, R. *J. Am. Chem. Soc.* **1999**, *121*, 5513.

(57) (a) Suresh, C. H.; Gadre, S. R. *J. Org. Chem.* **1999**, *64*, 2505. (b) Negri, F.; Castiglione, C.; Tommasini, M.; Zerbi, G. *J. Phys. Chem. A* **2002**, *106*, 3306.

(58) Bühl, M. *Chem.—Eur. J.* **37** **1998** 734.

(59) Foster, N. R.; Gieves, G. A.; Buchanan, J. W.; Flynn, N. D. Duncan, M. A. *J. Phys. Chem. A* **2000**, *104*, 11055.